

ProControl™ 1KE Plus Models for Management of Fluid and Air

3A6948A
EN

Use to monitor and actively manage 1K fluid pressure or flow rate, as well as track material use in permanently installed fluid supply systems. For professional use only.



Important Safety Instructions

Read all warnings and instructions in this manual and in the meter, regulator, and power supply manuals before using the equipment.
Save these instructions.

*See the G3000, S3000, G250 meter manual (308778) or Coriolis meter manual (313599) for flow meter maximum working pressure.
See page 3 for model information, including approvals.*

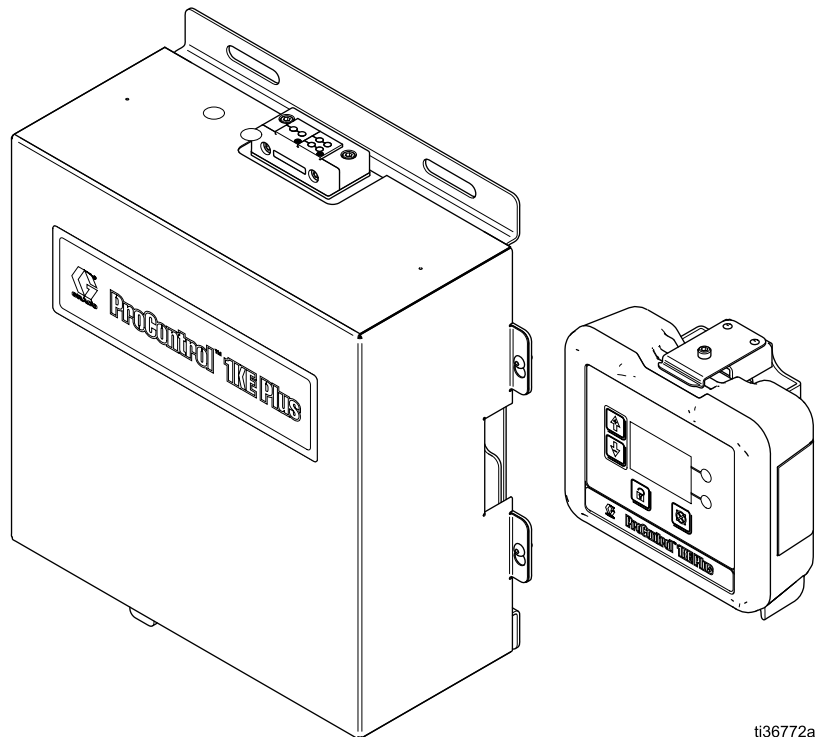

t136772a



Contents

Related Manuals	2	Password Screen	42
ProControl 1KE Plus Models	3	Setup Screens	43
ProControl 1KE Plus ADCM	3	Setup Screen 1: Job Target	43
ProControl 1KE Plus Pressure Ratings	4	Setup Screen 2: Maintenance	
ProControl 1KE Plus Model Selection		Totalizer	44
Matrix	5	Setup Screen 3: Grand Totals	45
ProControl 1KE Plus Selection Guide	6	Setup Screen 4: Calibration	45
Power Supply Selection Guide	7	Setup Screen 5: Flow Rate	46
Component Entity Parameters	9	Setup Screen 6: Pressure Transducer	47
Component Circuit Connector		Setup Screen 7: Pressure	48
Drawing	11	Setup Screen 8: Operator Input Limits	49
Warnings	12	Setup Screen 9: Additional Operator Input	
Overview	16	Limits and Timeouts	50
Components	17	Setup Screen 10: PID Data	51
Installation	19	Setup Screen 11: Fill Mode	51
Non-Hazardous Locations	19	Setup Screen 12: Flush Mode	52
Hazardous Locations	20	Setup Screen 13: Control Method	52
Grounding	23	Setup Screen 14: Modbus	53
Cable Connections to the Advanced Display		Setup Screen 15: Date and Time	53
Control Module (ADCM)	23	Setup Screen 16: Password	54
Air Connections	24	Calibrate the Meter	55
Fluid Connections	25	Set the Modbus Addresses	55
Communication Options	26	Update the Software	55
Operation	28	Deviations and Advisories	56
Pressure Relief Procedure	28	Troubleshooting	58
Fluid Regulator Operation	28	Battery Replacement Procedure	61
Flow Meter Operation	28	Parts	62
ADCM Module	29	Accessories	77
Display Information	29	Electrical Schematic	79
Operation Modes	29	Mounting Dimensions	80
Screen Navigation and Editing	29	Appendix A - Modbus Variable Map	81
Icons	30	Device Identification Registers	81
Control Method Considerations	32	Run Registers	82
Run Screens	34	Run Setpoint Registers	83
Screen 1: Run Operations	34	Setup Registers	84
Screen 2: Job Log Totalizer	39	Technical Specifications	88
Screen 3: Job Log History	40	Graco Standard Warranty	90
Screen 4: Event Log History	41		

Related Manuals

Manual No.	Description
308778	Volumetric Fluid Flow Meter, Instructions-Parts Manual
313599	Coriolis Meter Kits, Instructions-Parts Manual
3A0427	Low Flow Fluid Regulator, Instructions-Parts Manual
3A1244	Graco Control Architecture Module Programming, Instructions Manual
332013	DCM and ADCM, Instructions Manual
332196	IS Power Supply Modules, Instructions-Parts Manual



ProControl 1KE Plus Models

ProControl 1KE Plus ADCM

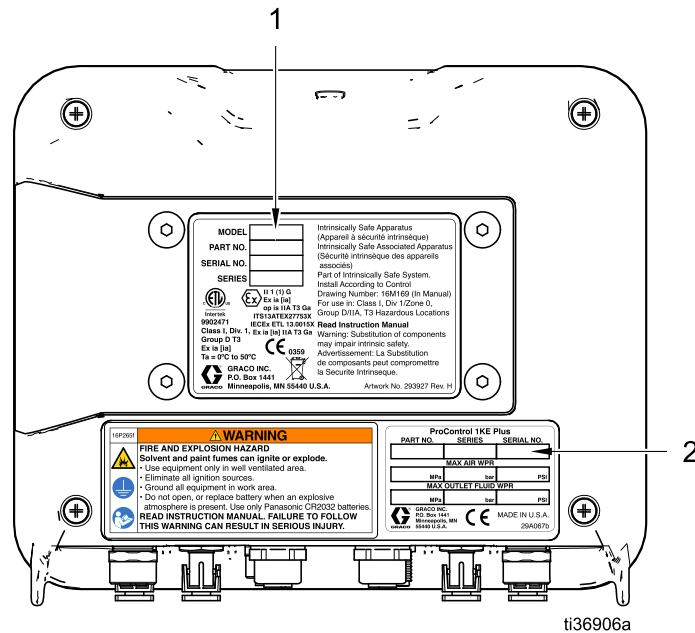
All Advanced Display Control Modules (ADCM) are base hardware model number 24L097 (Ref. 1) without application software. Model 24L097 is not available for separate sale.* See approval information in Manual 332013 and on this page. The small label (Ref. 2) on the back of the module shows the ProControl 1KE Plus model number.

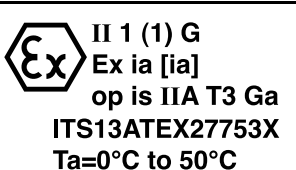

ti36906a

Model No.	Series	Description
24L097*	B	Advanced Display Control Module (ADCM), with no software loaded. See Manual 332013.
<div style="display: flex; justify-content: space-between; align-items: flex-start;"> <div style="text-align: center;">  <p>Intertek 9902471 Class I, Div. 1, Group D T3 Ex ia [ia] Ta=0°C to 50°C</p> </div> <div style="text-align: center;">  </div> <div style="text-align: center;">  <p>Ex ia [ia] op is IIA T3 Ga IECEx ETL 13.0015X Ta=0°C to 50°C</p> </div> </div> <p>Intrinsically Safe Apparatus Part of Intrinsically Safe System. For use in Class I, Division 1, Group D T3 Hazardous Locations</p>		

* See the [Parts, page 62](#), for replacement ADCM with software.

ProControl 1KE Plus Pressure Ratings

Air and Fluid Maximum Working Pressure by Part Number						
Part Number	Maximum Air Working Pressure			Maximum Fluid Working Pressure		
	PSI	MPa	bar	PSI	MPa	bar
25B283	N/A	N/A	N/A	N/A	N/A	N/A
25B284	N/A	N/A	N/A	4000	27.58	275.8
25B285	100	0.689	6.89	300	2.07	20.7
25B286	100	0.689	6.89	4000	27.58	275.8
25B287	100	0.689	6.89	300	2.07	20.7
25B288	100	0.689	6.89	N/A	N/A	N/A
25B289	100	0.689	6.89	N/A	N/A	N/A
25B290 Thru 25B299	100	0.689	6.89	100	0.689	6.89

ProControl 1KE Plus Model Selection Matrix

The numbered columns in the following table correspond to the numbered steps in [ProControl 1KE Plus Selection Guide, page 6](#).

Power supply modules are discussed in [Power Supply Selection Guide, page 7](#).

Component Selection Matrix					
1	2	3	(included)	(included)	4
ProControl Application Control Requirement	Fluid Flow Meter*	Fluid Regulator**	Pressure Transducer***	Current-to-Pressure I/P Transducer****	ProControl 1KE Plus System Models
ADCM w/software and bracket only	N/A	N/A	N/A	N/A	25B283
Flow Monitor (ADCM w/G3000 and 5 ft (1.5 m) cable, no fluid panel)	✓	N/A	N/A	N/A	25B284
Flow Monitor with open setpoint fluid pressure control (includes fluid panel and I/P to operate fluid pressure regulator)	✓	✓	N/A	1	25B285
	✓	—	N/A	1	25B286
	—	✓	N/A	1	25B287
	—	—	N/A	1	25B288
Gun Atomizing Air Control	N/A	N/A	N/A	1	25B289
Closed Loop Fluid Pressure Control	N/A	✓	✓	1	25B290
	N/A	—	✓	1	25B291
Closed Loop Fluid Pressure or Fluid Flow Control	✓	✓	✓	1	25B292
	✓	—	✓	1	25B293
	—	✓	✓	1	25B294
	—	—	✓	1	25B295
Closed Loop Fluid Pressure/Flow + Gun Atomizing Air Control	✓	✓	✓	2	25B296
	✓	—	✓	2	25B297
	—	✓	✓	2	25B298
	—	—	✓	2	25B299

✓ = Included

— = Not included. However, the system will accommodate a user-supplied component.

* A Graco G3000 high-pressure meter (289813) is used in models sold with a fluid flow meter. If you intend to supply your own fluid flow meter, order a model without a checkmark below. Make sure the fluid flow meter is appropriate for fluid compatibility, viscosity, flow rate range, etc.

** A Graco 1:1 low-flow air-operated regulator (24C375) is used in models sold with a fluid regulator. If you intend to supply your own air-operated fluid

regulator, order a model without a checkmark below. Make sure the fluid regulator is appropriate for fluid pressure range, material compatibility, viscosity, flow rate range, etc. (**Note:** Back pressure at the fluid regulator outlet must be a minimum of 10 psi (0.7 bar).)

*** All models intended for use with a pressure transducer come with a low-pressure 100 psi (6.9 bar) transducer.

**** For managing fluid and atomizing air control. The number below indicates the quantity included.

ProControl 1KE Plus Selection Guide

(Numbered steps 1–4 correspond to the numbered columns in the [ProControl 1KE Plus Model Selection Matrix, page 5](#).)

1. Choose level of application control needed.
2. Determine flow meter, if applicable for level of control chosen. (Gun Atomizing Air Control and Closed Loop Fluid Pressure Control units do not use a flow meter.)

The G3000 meter is the standard recommended meter.

Note: Not all meters are approved for hazardous locations. See your flow meter manual for details.

3. Determine fluid pressure regulator, if applicable for the level of control chosen. (The Gun Atomizing Air Control unit, 25B289, does not use a fluid pressure regulator.)



The Graco 24C375 1:1 Low Flow Regulator is standard.

4. Select base ProControl 1KE Plus model part number from the [ProControl 1KE Plus Model Selection Matrix, page 5](#).

Note

ProControl 1KE Plus units come with 5 ft. (1.5 m) cable lengths to allow mounting the user control interface (ADCM) near the fluid panel. If a more remote mounting is required, purchase the appropriate extension cables, available in 50 ft. (16 m) lengths. See [Accessories, page 77](#).

Power Supply Selection Guide

				
To prevent Fire and Explosion, when using a ProControl 1KE Plus system in a hazardous location, use a power supply with an IS barrier.				

Power supply modules are ordered separately and depend on whether your ProControl 1KE Plus system is being used in a non-hazardous or hazardous location. Additional considerations for each location are discussed below.

Note

Power supply modules come with power cables to connect to port 3 of the ProControl 1KE Plus ADCM user interface.

Non-Hazardous Locations

Order power supply 16V680 (AC/DC Converter) and choose a power cord below.

Note

The 16V680 AC/DC Converter has an IEC-320-C13 female input power connection and a 68 in. (1.7 m) output cord to connect to port 3 of the ProControl 1KE Plus ADCM user interface.

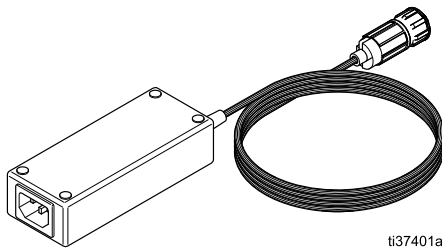

- 245202 – 120 in. (3 m) North American 120 VAC power cord.
- 116281 – 72 in. (1.8 m) extension (Male x Female) IEC-320 cord.
- 242001 – 8 in. (0.2 m) IEC-320 European-style power cord.
- 242005 – 8 in. (0.2 m) IEC-320 ANZ-style power cord.

Hazardous Locations

To determine the correct power supply module, answer these questions:

Yes	No	
_____	_____	Will you be using ProControl 1KE Plus models 25B296–25B299 for fluid and atomizing air control?
_____	_____	Would you potentially want to upgrade a ProControl 1KE Plus model in the future for use with fluid and atomizing air control?
_____	_____	Do you need to power more than one ProControl 1KE Plus unit, or want the ability to power up to three units from one power supply module in the future?
_____	_____	Will your application ever require greater than 50 psi (3.4 bar) of fluid pressure at the outlet of the ProControl 1KE Plus for units with the standard Graco 24C375 1:1 Low Flow Regulator; or, for units using an alternate air-operated fluid regulator, will your application ever require greater than 50 psi (3.4 bar) of air pilot pressure to the fluid regulator?

If you answered “Yes” to any of these questions, order the 26C724 IS G-Barrier Power Supply Module.

Note

Up to three total ProControl 1KE Plus models of any configuration can be powered by a single G-Barrier. If you are adding a ProControl 1KE Plus model to an existing 26C724 G-Barrier Power Supply Module, order a power cable kit 19Y499 (50 ft (16 m)) or 19Y502 (100 ft (32m)).

If you answered “No” to all of these questions, you may consider ordering the 16M167 Single IS Barrier Power Supply Module.

Note

The 16M167 Single IS Barrier Power Supply Module has power limitations. It cannot be used on ProControl 1KE Plus models that require greater than 50 psi (3.4 bar) of fluid pressure (50 psi (4.4 bar) of pilot air pressure for alternate air-operated fluid regulator use), or on units that control fluid and atomizing air.

Power supply notes based upon ProControl 1KE Plus model number (see column 4 in [ProControl 1KE Plus Model Selection Matrix, page 5](#)).

- For models 25B296–25B299, or models that may need to be upgraded to include atomizing air control and fluid pressure or flow control, the power consumption will require a Graco IS approved G-Barrier power module (26C724). Systems that may operate above 50 psi (3.5 bar) require the G-Barrier power module (26C724) to guarantee optimal performance.
- For models 25B284–25B295, these can be powered by a Graco G-Barrier power module (26C724) or a single IS barrier output power module (16M167).





Component Entity Parameters

The following entity parameter values are taken from the ADCM control drawing for base model 24L097 (16M169) and from the IS Power Supply Module manual.

ADCM (24L097) with 16M167 Power Supply (with a Pepperl+Fuchs Z713 barrier)		
ADCM Power Input (Port 3)		Power Supply
U _i = 17.9 V	≥	U _o = 15.75 V
I _i = 725 mA	≥	I _o = 723 mA
P _i = 2.9 W	≥	P _o = 2.84 W
C _i = 2.3 μF	≤	C _o = 5.38 μF
L _i = 50 μH	≤	L _o = 570 μH
ADCM (24L097) with 26C724 Power Supply (with G-Barrier)		
ADCM Power Input (Port 3)		Power Supply
U _i = 17.9 V	≥	U _o = 16.4 V
I _i = 725 mA	≥	I _o = 592.2 mA
P _i = 2.9 W	≥	P _o = 2.82 W
C _i = 2.3 μF	≤	C _o = 2.4 μF
L _i = 50 μH	≤	L _o = 64 μH
Meter Sensor (24W651) with ADCM (24L097)		
Meter Sensor		ADCM Digital Output (Port 4)
U _i = 30 V	≥	U _o = 17.9 V
I _i = 110 mA	≥	I _o = 100 mA
P _i = 800 mW	≥	P _o = 441 mW
C _i = 0.4 μF	≤	C _o = 4.8 μF
L _i = 10 μH	≤	L _o = 20,000 μH
25P594 Light Kit with ADCM (24L097)		
Light Kit		ADCM Digital Output (Port 4)
U _i = 30 V	≥	U _o = 17.9 V
I _i = 1000 mA	≥	I _o = 217 mA
P _i = 3400 mW	≥	P _o = 937 mW
C _i = 0 μF	≤	C _o = 4.8 μF
L _i = 0 μH	≤	L _o = 5000 μH

Class I, Division 1, Group D, T3



16H282 Pressure Transducer with ADCM (24L097)			<p>Simple Apparatus</p> <p>Class I, Division 1, Group D, T4</p> 
*Pressure Transducer		ADCM Analog Output (Port 7)	
U _i = 6 V	≥	U _o = 5.88 V	
I _i = 61 mA	≥	I _o = 61 mA	
P _i = 90 mW	≥	P _o = 90 mW	
C _i = 5310 pF	≤	C _o = 700 μF	
L _i = 8.52 μH	≤	L _o = 50,000 μH	
513937 Pressure Switch with ADCM (24L097)			<p>Simple Apparatus</p> <p>Class I, Division 1, Group D, T4</p> 
*Pressure Switch		ADCM Analog Output (Port 8)	
U _i = 17.9 V	≥	U _o = 17.9 V	
I _i = 73 mA	≥	I _o = 124 mA	
P _i = 1.25 W	≥	P _o = 540 mW	
C _i = 10,800 pF	≤	C _o = 2 μF	
L _i = 9.119 μH	≤	L _o = 15,000 μH	
16P784 I/P Transducer with ADCM (24L097)			<p>Class I, Division 1, Group D, T3</p> 
I/P Transducer		ADCM Analog Output (Port 8)	
U _i = 30 V	≥	U _o = 17.9 V	
I _i = 125 mA	≥	I _o = 124 mA	
P _i = 700 mW	≥	P _o = 540 mW	
C _i = 10,800 pF	≤	C _o = 2 μF	
L _i = 9.119 μH	≤	L _o = 15,000 μH	
119159 Air Flow Switch with ADCM (24L097)			<p>Simple Apparatus</p> <p>Class I, Division 1, Group D, T4</p> 
*Air Flow Switch		ADCM Analog Output (Port 10)	
U _i = 17.9 V	≥	U _o = 5.88 V	
I _i = 73 mA	≥	I _o = 61 mA	
P _i = 1.25 W	≥	P _o = 90 mW	
C _i = 1995.3 pF	≤	C _o = 700 μF	
L _i = 8.133 μH	≤	L _o = 50,000 μH	

* Simple Apparatus in accordance with UL/EN/IEC 60079-11, clause 5.7.

Component Circuit Connector Drawing

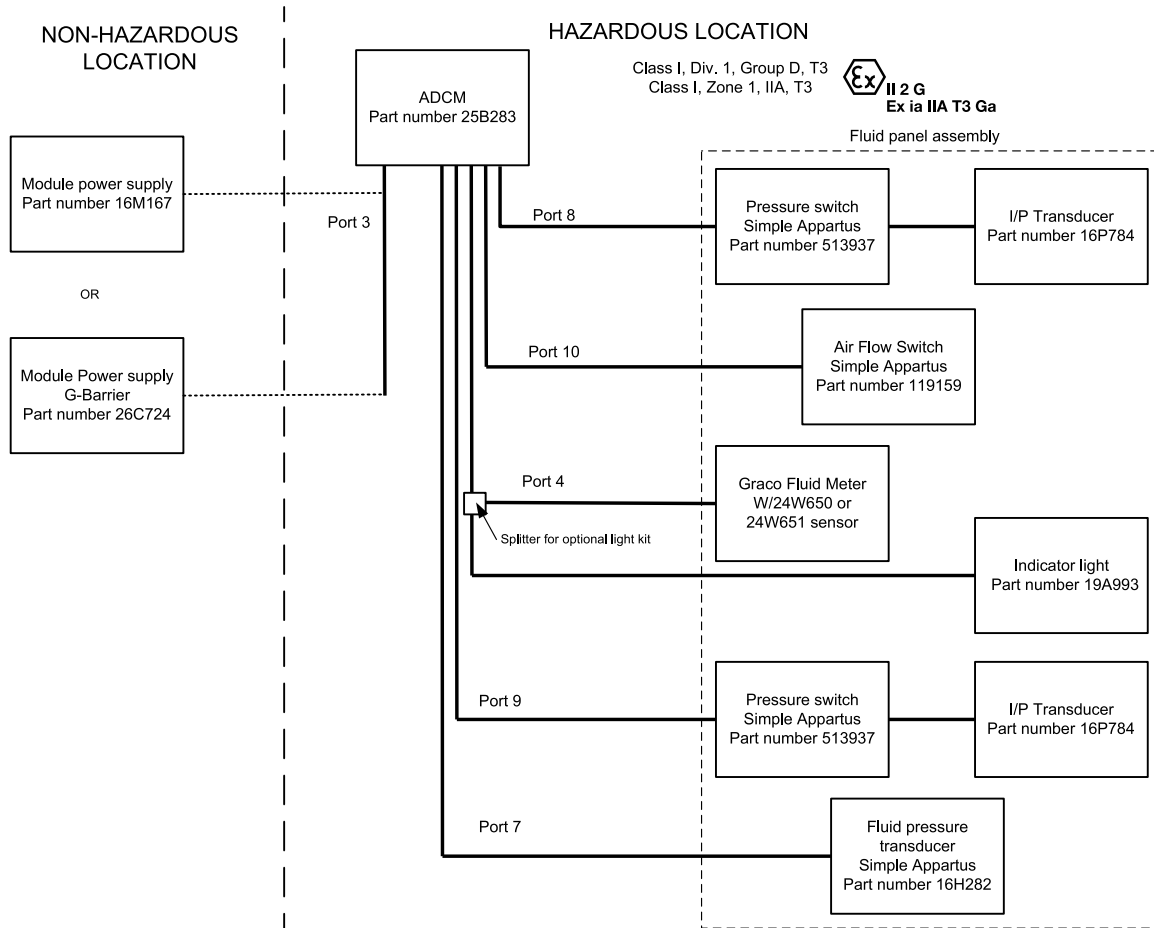









Figure 1 Component Circuit Connector Drawing

Optional Cables by Port		
Port #	Part #	Length
3	16K509	50 ft (15.2 m)
	16K615	100 ft (30.5 m)
4	18B244	50 ft (15.2 m)
7	16V381	50 ft (15.2 m)
8	16V071	50 ft (15.2 m)
9	16V071	50 ft (15.2 m)
10	16V381	50 ft (15.2 m)

Warnings

The following warnings are for the setup, use, grounding, maintenance and repair of this equipment. The exclamation point symbol alerts you to a general warning and the hazard symbol refers to procedure-specific risks. When these symbols appear in the body of this manual or on warning labels, refer back to these Warnings. Product-specific hazard symbols and warnings not covered in this section may appear throughout the body of this manual where applicable.

 WARNING	
<div style="margin-bottom: 10px;"></div> <div style="margin-bottom: 10px;"></div> <div style="margin-bottom: 10px;"></div> <div style="margin-bottom: 10px;"></div> <div></div>	<p>FIRE AND EXPLOSION HAZARD</p> <p>Flammable fumes, such as solvent and paint fumes, in work area can ignite or explode. Paint or solvent flowing through the equipment can cause static sparking. To help prevent fire and explosion:</p> <ul style="list-style-type: none"> • Use equipment only in well ventilated area. • Eliminate all ignition sources; such as pilot lights, cigarettes, portable electric lamps, and plastic drop cloths (potential static sparking). • Ground all equipment in the work area. See Grounding instructions. • Never spray or flush solvent at high pressure. • Keep work area free of debris, including solvent, rags and gasoline. • Do not plug or unplug power cords, or turn power or light switches on or off when flammable fumes are present. • Use only grounded hoses. • Hold gun firmly to side of grounded pail when triggering into pail. Do not use pail liners unless they are anti-static or conductive. • Stop operation immediately if static sparking occurs or you feel a shock. Do not use equipment until you identify and correct the problem. • Keep a working fire extinguisher in the work area. <p>Static charge may build up on plastic parts during cleaning and could discharge and ignite flammable vapors. To help prevent fire and explosion:</p> <ul style="list-style-type: none"> • Clean plastic parts only in a well ventilated area. • Do not clean with a dry cloth.
<div style="margin-bottom: 10px;"></div> <div></div>	<p>ELECTRIC SHOCK HAZARD</p> <p>This equipment must be grounded. Improper grounding, setup, or usage of the system can cause electric shock.</p> <ul style="list-style-type: none"> • Turn off and disconnect power at main switch before disconnecting any cables and before servicing or installing equipment. • Connect only to grounded power source. • All electrical wiring must be done by a qualified electrician and comply with all local codes and regulations.











WARNING





INTRINSIC SAFETY

Intrinsically safe equipment that is installed improperly or connected to non-intrinsically safe equipment will create a hazardous condition and can cause fire, explosion, or electric shock. Follow local regulations and the following safety requirements.

- Installation should be in accordance with ANSI/ISA RP12.06.01 “Installation of Intrinsically Safe Systems for Hazardous (Classified) Locations” and the National Electrical Code® (ANSI/NFPA 70).
- Installation in Canada should be in accordance with the Canadian Electrical Code, CSA C22.1, Part 1, Appendix F.
- For ATEX, install per EN 60079–14 and applicable local and national codes.
- Equipment that comes in contact with intrinsically safe terminals must meet the entity parameter requirements specified in Control Drawing 16M169. See Appendix A in Manual 332013. This includes safety barriers, DC voltage meters, ohmmeters, cables, and connections. Remove the unit from the hazardous area when servicing.
- Without the safety barrier, the equipment is no longer intrinsically safe and must not be operated in hazardous locations, as defined in article 500 of the National Electrical Code (USA) or your local electrical code.
- Do not install equipment approved only for non-hazardous location in a hazardous area. See the ID label for the intrinsic safety rating for your model.
- Do not use intrinsically safe equipment with a power supply that has no barrier. Intrinsic safety may be compromised.
- Ground the power supply. A voltage limiting safety barrier must be properly grounded to be effective. For proper grounding, use a 12 gauge minimum ground wire. The barrier’s ground must be within 1 ohm of true earth ground.
- Do not remove any cover until power has been removed.
- Do not substitute system components as this may impair intrinsic safety.

 <h1 style="margin: 0;">WARNING</h1>	
    	<p>SKIN INJECTION HAZARD</p> <p>High-pressure fluid from gun, hose leaks, or ruptured components will pierce skin. This may look like just a cut, but it is a serious injury that can result in amputation. Get immediate surgical treatment.</p> <ul style="list-style-type: none"> Do not spray without tip guard and trigger guard installed. Engage trigger lock when not spraying. Do not point gun at anyone or at any part of the body. Do not put your hand over the spray tip. Do not stop or deflect leaks with your hand, body, glove, or rag. Follow the Pressure Relief Procedure when you stop spraying and before cleaning, checking, or servicing equipment. Tighten all fluid connections before operating the equipment. Check hoses and couplings daily. Replace worn or damaged parts immediately.
 	<p>EQUIPMENT MISUSE HAZARD</p> <p>Misuse can cause death or serious injury.</p> <ul style="list-style-type: none"> Do not operate the unit when fatigued or under the influence of drugs or alcohol. Do not exceed the maximum working pressure or temperature rating of the lowest rated system component. See Technical Specifications in all equipment manuals. Use fluids and solvents that are compatible with equipment wetted parts. See Technical Specifications in all equipment manuals. Read fluid and solvent manufacturer's warnings. For complete information about your material, request Safety Data Sheet (SDS) from distributor or retailer. Do not leave the work area while equipment is energized or under pressure. Turn off all equipment and follow the Pressure Relief Procedure when equipment is not in use. Check equipment daily. Repair or replace worn or damaged parts immediately with genuine manufacturer's replacement parts only. Do not alter or modify equipment. Alterations or modifications may void agency approvals and create safety hazards. Make sure all equipment is rated and approved for the environment in which you are using it. Use equipment only for its intended purpose. Call your distributor for information. Route hoses and cables away from traffic areas, sharp edges, moving parts, and hot surfaces. Do not kink or over bend hoses or use hoses to pull equipment. Keep children and animals away from work area. Comply with all applicable safety regulations.

 WARNING	
	<p>TOXIC FLUID OR FUMES HAZARD</p> <p>Toxic fluids or fumes can cause serious injury or death if splashed in the eyes or on skin, inhaled, or swallowed.</p> <ul style="list-style-type: none">• Read Safety Data Sheets (SDSs) to know the specific hazards of the fluids you are using.• Store hazardous fluid in approved containers, and dispose of it according to applicable guidelines.
	<p>PERSONAL PROTECTIVE EQUIPMENT</p> <p>Wear appropriate protective equipment when in the work area to help prevent serious injury, including eye injury, hearing loss, inhalation of toxic fumes, and burns. Protective equipment includes but is not limited to:</p> <ul style="list-style-type: none">• Protective eyewear, and hearing protection.• Respirators, protective clothing, and gloves as recommended by the fluid and solvent manufacturer.

Overview

The ProControl 1KE Plus is an electronic flow control and fluid monitoring system. Depending on the model, the ProControl 1KE Plus can perform the following functions:

- Manages fluid pressure or flow rate by either open-loop or closed-loop control for manual or automatic systems.
- Shows real-time fluid flow rate or pressure.
- Monitors and reports overall fluid use.
- Provides password protected settings to lock or limit the range of fluid and atomizing air setpoint adjustments that an operator may use.
- Alarms if the flow rate is too high or too low for the user-set targets.
- Alarms if the fluid pressure is too high or too low for the user-set targets.
- Manages atomizing gun air pressure by open-loop control.
- Alarms when the maintenance total is reached for the user-set target.
- Displays a log of the last 100 alarms.
- Tracks sprayed material and flush material usage by job.
- Displays logs of the last 500 jobs.
- Allows for integration to plant PLC/System Control and remote monitoring through available options listed in [Accessories, page 77](#).

Components

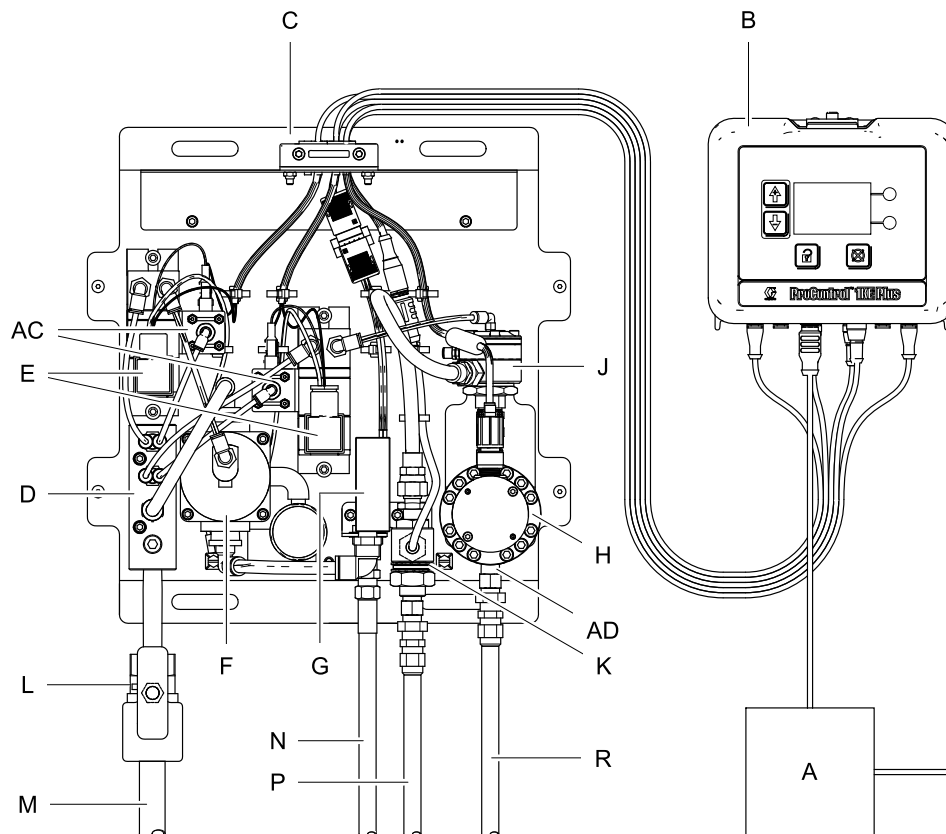

Figure 2 View of Fluid Panel with cover removed

Key:

Key:

A Power Supply — Supplies power to the system.

B ProControl 1KE Plus Advanced Display Control Module (ADCM) — User interface for configuring system setup, selecting operating modes, setting flow/pressure targets, logging jobs, monitoring status, and viewing material usage, job, and alarm logs. Fiber optic ports are available for communicating with an external PLC.

C Fluid Panel — Contains the air and fluid hardware components.

Note

Alternative flow meters and fluid regulators can be installed adjacent to the fluid panel and plumbed in as needed for application and material compatibility.

D Air Manifold — Distributes air to the control devices and atomizing air for equipped models.

E Fluid and Air Regulator I/P Transducers — Current to pressure (I/P) transducers for controlling fluid and air regulator pressure settings by the ADCM.

F Air Regulator — Air-operated air-pressure regulator for controlling atomizing air pressure to the applicator gun.

G Air Flow Switch (AFS) — Air flow switch used to determine when applicator gun is triggered. The AFS is required on systems for active closed-loop pressure or flow control.

H Fluid Flow Meter — Measures flow rate and material usage.

J Fluid Regulator — Air-operated fluid-pressure regulator for controlling fluid pressure to the applicator gun.

K Fluid Pressure Transducer — Device used for measuring fluid pressure. The pressure transducer is required on systems for active closed-loop fluid pressure or flow control.

L 2-Way Vented Valve — Supply air shut-off valve.

Overview

Key:

- M*** **Air Supply Line** — See [Technical Specifications, page 88](#), for pressure and air-cleanliness requirements.
- N*** **Air Outlet Line to Gun**
- P*** **Fluid Outlet Line to Gun**
- R*** **Fluid Inlet Line** — See [Technical Specifications, page 88](#), for pressure requirements.

Key:

- AC** **Air Pressure Cut-Out Switches** — Used to protect the I/P transducers when air pressure is removed and the I/P transducers are being electrically powered by the ADCM.
- AD** **Check Valve**
 - * Required components provided by user.

Installation

Non-Hazardous Locations

NOTE: Non-hazardous power supply modules (see [ProControl 1KE Plus Selection Guide, page 6](#)) are supplied with an AC/DC Converter. Users must select and order an appropriate power cord for the local region. In areas with power connections that are different than the options provided in the [ProControl 1KE Plus Selection Guide, page 6](#) , users must provide a power supply cord with an IEC 320-C13 female converter. See [Technical Specifications, page 88](#), for power requirements.

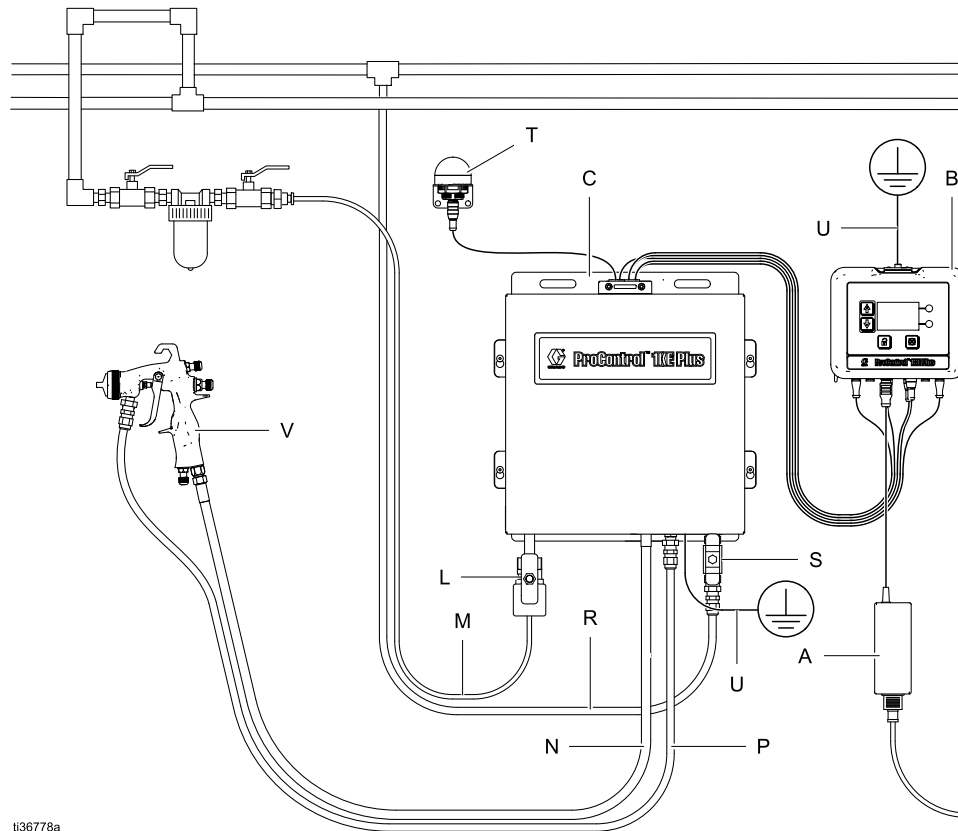

ti36778a



Key:

- A** Power Supply Module
- B** ProControl 1KE Plus ADCM
- C** Fluid Panel
- L** 2-Way Vented Valve
- M*** Air Supply Line
- N*** Air Outlet Line to Gun
- P*** Fluid Outlet Line

Key:

- R*** Fluid Inlet Line
- S*** Fluid Inlet Shut-off Valve
- T** Accessory Light Tower
- U** Ground Wire
- V*** Gun
- *** User-provided

Hazardous Locations

				
<p>Do not substitute or modify system components as this may impair intrinsic safety. For installation, maintenance, or operation instructions, read instruction manuals. Do not install equipment approved only for non-hazardous locations in a hazardous location. See the identification label for the intrinsic safety rating for your equipment.</p>				

Intrinsically safe (IS) equipment should not be used with a power supply that has no barrier. Do not move units from a non-IS setup to an IS setup. IS equipment that has been used with a non-IS power supply must not be returned to a hazardous location. Always use an intrinsically safe power supply with IS equipment.

- Installation should be in accordance with ANSI/ISA RP12.06.01, "Installation of Intrinsically Safe Systems for Hazardous (Classified) Locations," and the National Electrical Code® (ANSI/NFPA 70).
- Installation in Canada should be in accordance with the Canadian Electrical Code, CSA C22.1, Part 1, Appendix F.
- For ATEX, install per EN 60079-14 and applicable local and national codes.
- Multiple earthing of components is allowed only if a high integrity equipotential system is realized between the points of bonding.
- Do not remove any cover until power has been removed.
- Install ADCM according to Control Drawing Number 16M169. See Appendix A in Manual 332013.

For Fluid Control Systems without Atomizing Air and Fluid Pressure Operation Capability below 50 psi (3.5 bar)

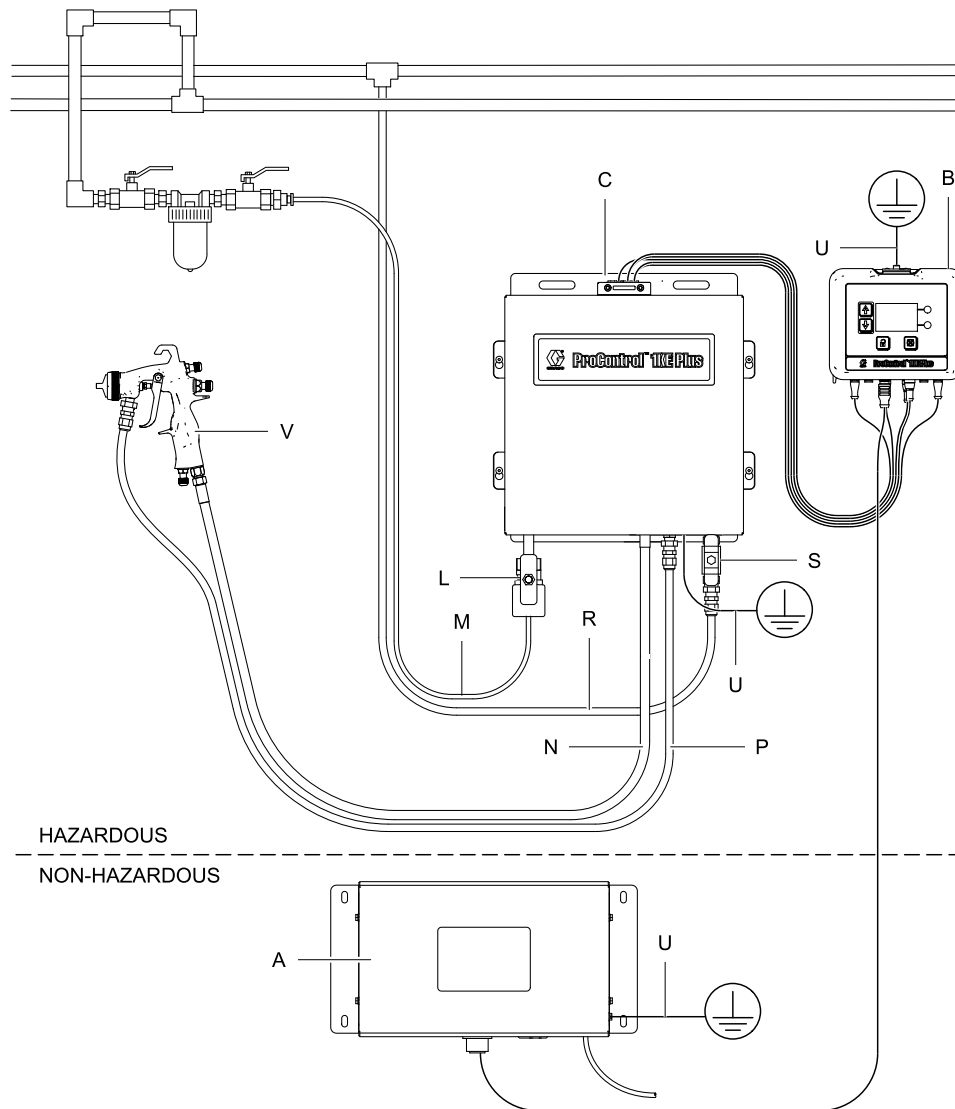

ti36779a

Key:

- A** Power Supply Module (see [ProControl 1KE Plus Selection Guide, page 6](#), for alternate power supply module options)
- B** ProControl 1KE Plus ADCM
- C** Fluid Panel
- L** 2-Way Vented Valve
- M*** Air Supply Line
- N*** Air Outlet Line to Gun

Key:

- P*** Fluid Outlet Line
- R*** Fluid Inlet Line
- S*** Fluid Inlet Shut-off Valve
- U** Ground Wire
- V*** Gun
- *** User-provided.

Installation

For Fluid Control Systems with Atomizing Air or Fluid Pressure Operation Capability above 50 psi (3.5 bar)

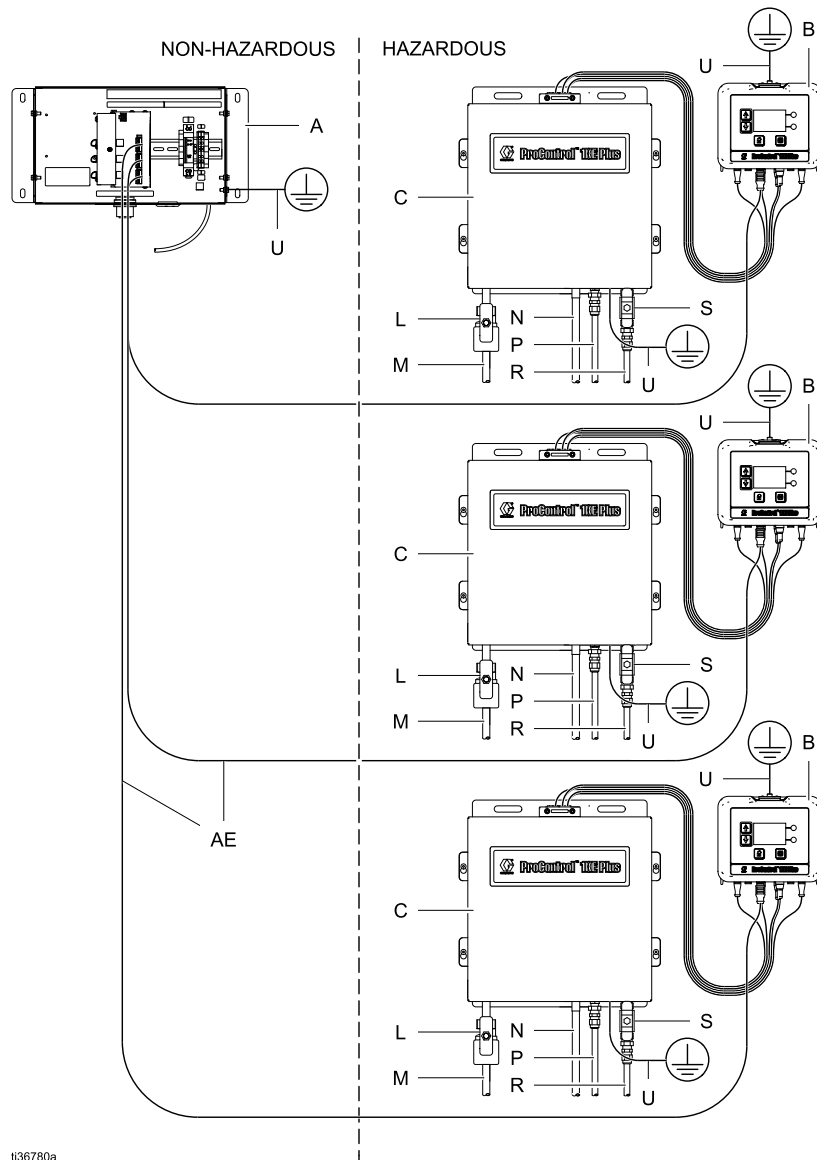

1136780a





Key:

- A** Power Supply (see [ProControl 1KE Plus Selection Guide, page 6](#), for alternate power supply module options)
- B** ProControl 1KE Plus ADCM
- C** Fluid Panel
- L** 2-Way Vented Valve
- M*** Air Supply Line
- N*** Air Outlet Line to Gun
- P*** Fluid Outlet Line

Key:

- R*** Fluid Inlet Line
- S*** Fluid Inlet Shut-off Valve
- U** Ground Wire
- V*** Gun
- AE** Power cables, available for use with additional ProControl 1KE Plus units (see [ProControl 1KE Plus Selection Guide, page 6](#))
- *** User-provided.

Grounding

				
<p>The equipment must be grounded to reduce the risk of static sparking and electric shock. Electric or static sparking can cause fumes to ignite or explode. Improper grounding can cause electric shock. Grounding provides an escape wire for the electric current.</p>				

1. **Power Supply Modules 16M167 and 26C724:**
Refer to the IS Power Supply Modules manual.

2. **ProControl 1KE Plus ADCM:** Connect a ground wire to the screw on the top of the bracket. Connect the other end to a true earth ground. In an IS system, the ProControl 1KE Plus ADCM is also grounded by connection to the grounded power supply.
3. **External Mounted Flow Meter:** Follow the instructions in manual 308778 (G3000, S3000, G250) or manual 313599 (Coriolis) to ground the flow meter and check its electrical grounding continuity.
4. **Fluid and Air Control Panel:** Connect a ground wire to the screw on the 1KE Plus fluid panel. Connect the other end to a true earth ground.
5. **Fluid Supply:** Ground the fluid supply system.

Cable Connections to the Advanced Display Control Module (ADCM)

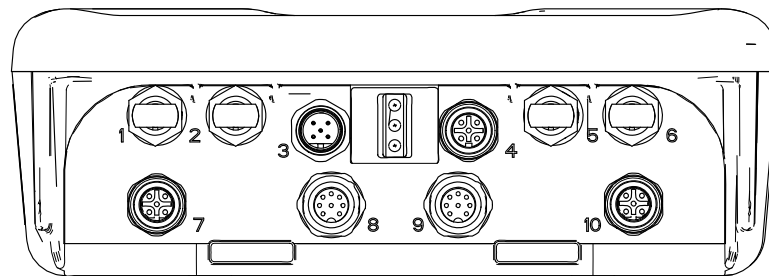

ti19093a

Port	Description	Connection
1	Fiber Optic Receiver	Red Lead from TX on Fiber Optic Converter (PN 16K465) or from Port 6 on another ProControl 1KE Plus (or Informer)
2	Fiber Optic Transmitter	Black Lead to RX on Fiber Optic Converter (PN 16K465) or to Port 5 on another ProControl 1KE Plus (or Informer)
3	Power	From Power Supply
4	Digital Input/Output	To/From Meter and Light Tower (Accessory)
5	Fiber Optic Receiver	Black Lead from Port 2 on another ProControl 1KE Plus (or Informer)
6	Fiber Optic Transmitter	Red Lead to Port 1 on another ProControl 1KE Plus (or Informer)
7	Analog Input	To/From Pressure Transducer Cable
8	Flow Control	To/From Flow Control Cable
9	Atomizing Air Control	To/From Atomizing Air Control Cable
10	Analog Input	From Air Flow Switch (AFS) or Gun Trigger

Air Connections

Connect incoming air supply to the air supply shut-off valve (L) 1/4 npt (f). (See [Components, page 17.](#))

NOTICE

To avoid damage to the I/P transducer, use clean, dry, oil-free air, filtered through at least a 40 micron filter.

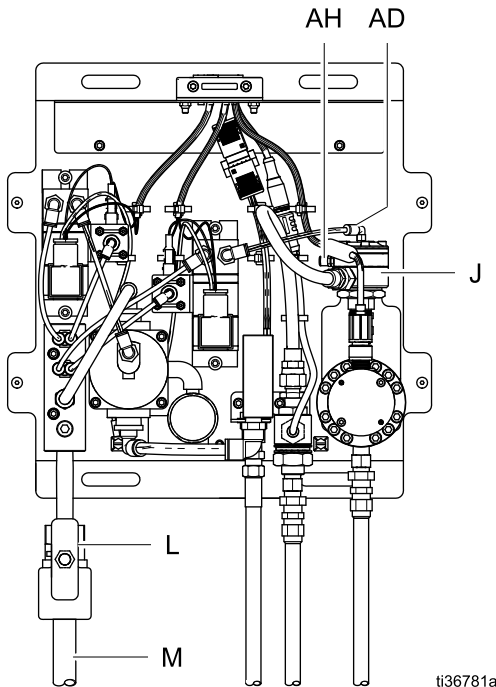

See [Technical Specifications, page 88](#), for air pressure and consumption ratings. The I/P transducer exhausts a small amount of air whenever air is connected, regardless of whether the system is operating. Refer to your applicator gun air pressure and consumption ratings and size your air supply accordingly.

The ProControl 1KE Plus uses an Air Flow Switch (AFS) to detect when the applicator gun is triggered. Do not bypass the AFS. See [Accessories, page 77](#), for an alternate gun trigger air pressure switch that can be used in place of the provided AFS.

NOTE:

- The side port (AH) on the fluid regulator can be used for high-speed flushing with an independent air source. Set the air pressure **higher** than the top port (AD) air pressure. See [Setup Screen 11: Fill Mode, page 51](#), and [Setup Screen 12: Flush Mode, page 52](#), for the preferred method of controlling fill and flush pressure.
- Flushing air pressure must be removed from the side port (AH) to return to the previous flow setting.

Fluid Connections

Note: ProControl 1KE Plus model 25B289 is for applicator gun atomizing air control only and will have no fluid inlet or outlet connections.

Fluid Inlet Connections

For models that come equipped with the standard G3000 Fluid Meter, connect incoming fluid to the provided meter check valve fitting 1/4 npt(m) inlet port. Refer to instruction manual 308778 for additional details regarding installation and operation of the G3000 meter.

Note

Users are responsible for providing a fluid inlet shut-off valve or other means of isolating the fluid supply.

See [Alternate Flow Meter and Fluid Regulator Installation, page 26](#). Users must provide fluid fittings and hose when using alternate Flow Meters or Fluid Regulators.

Fluid Outlet Connections

The ProControl 1KE Plus fluid outlet connection will be made at the Fluid Pressure Transducer port 1/4 npt(f) for most models. For Flow Monitor models (25B285–25B288), the fluid outlet connection will be made at the fluid regulator outlet.

Note

For proper operating performance using open- or closed-loop pressure or flow control, the ProControl 1KE Plus Fluid Pressure I/P Transducer must operate at an outlet air pressure of at least 10 psi (0.7 bar). When using 1:1 air-operated fluid regulators, this means that the minimum pressure drop between the 1KE fluid outlet and the gun nozzle is at least 10 psi (0.7 bar) during the expected spray conditions (flow rate ranges) and material viscosities that will be used. If the back pressure drops below 7 psi (0.5 bar), the performance may become inconsistent. Back pressure can be increased by using a smaller diameter fluid hose or a longer hose between the 1KE Plus and the spray gun. An alternate solution would be to use a Graco 24E471 1:2 Ratio Fluid Regulator or a 24E472 1:3 Fluid Regulator, see instruction manual 3A0427 for details. These alternate ratio fluid regulators have lower fluid outlet pressure ranges, but will allow the 1KE Plus Fluid Pressure I/P Transducer to operate at a higher air control pressure.

Note

If the application requires greater than 50 psi (3.5 bar) of fluid pressure at the ProControl 1KE Plus outlet, you must use either 16V680 non-hazardous location power supply module or the 26C724 G-Barrier hazardous location power supply module. The 16M167 hazardous location power supply module output is limited and will not drive the fluid pressure I/P transducer to greater than 50 psi (3.5 bar).

Alternate Flow Meter and Fluid Regulator Installation

For application of fluid compatibility, alternate flow meters or fluid regulators can be used with the ProControl 1KE Plus. See [Accessories, page 77](#), for a list of optional Graco meters and regulators.

It is recommended that alternate meters or regulators be mounted adjacent to the fluid panel to ensure optimal control.

See [Electrical Schematic, page 79](#), for meter power and signal connections to the 1KE Plus.

For alternate fluid regulators, connect a 5/32 in. OD air tubing line from the fluid I/P transducer control “out” port to the fluid regulator air control inlet port. The pilot air line should not exceed 10 ft (3 m).

Communication Options

Graco Accessories are available to enable communication with a Programmable Logic Controller (PLC) or Personal Computer (PC).

- The Fiber Optic Converter (Graco Kit 24N978) enables Modbus RTU communication with a user-supplied PLC using a serial cable.
- The Fiber Optic-to-Serial Converter Module (Graco Kit 24R086) includes the fiber optic-to-serial converter and power supply inside of an enclosure. See the Communication Kits instruction manual (332356) for additional details.

The communication kits come with installation and setup directions necessary for their use with the ProControl 1KE Plus. See [Appendix A - Modbus Variable Map, page 81](#), for registration details.

Typical Installation with Data Communications

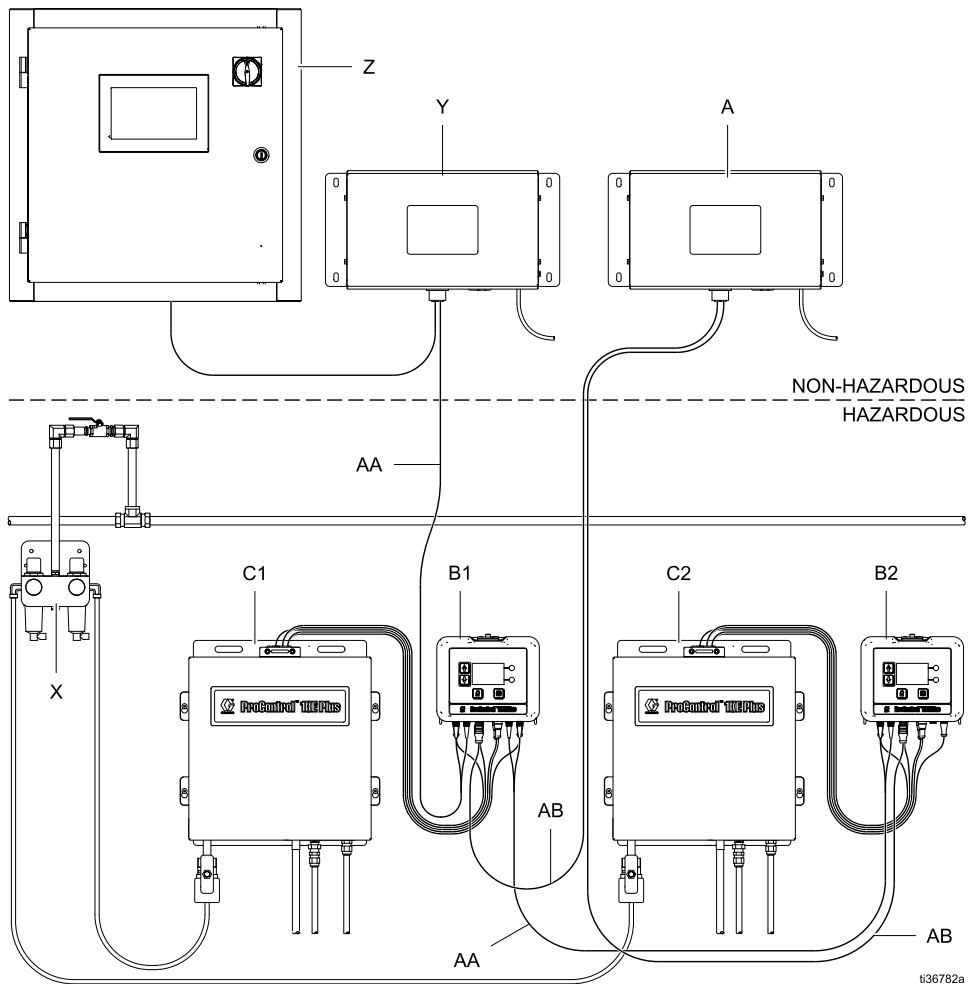

Key		
Item	Description	Type
A	Power Supply Module (26C724 shown)	Supplied; ordered separately
B1 and B2	ProControl 1KE Plus ADCM	Supplied
C1 and C2	ProControl 1KE Plus Fluid Panel	Supplied
X	Air Control Module	Accessory
Y	Communications Module (24R086)	Accessory
Z	PLC	Customer-Supplied
AA	Fiber Optic Cable	Accessory
AB	Power Cable	Supplied

Operation

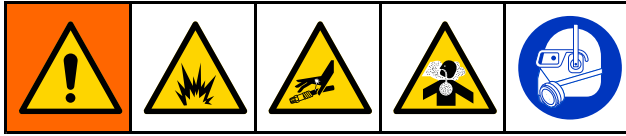

Fluid Regulator Operation

Follow instructions in the fluid regulator manual to set up, flush, and adjust the fluid regulator prior to use.



Pressure Relief Procedure

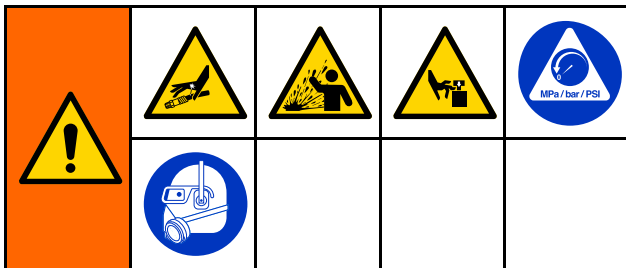

Follow the Pressure Relief Procedure whenever you see this symbol.



This equipment stays pressurized until pressure is manually relieved. To help prevent serious injury from pressurized fluid, such as skin injection, splashing fluid and moving parts, follow the Pressure Relief Procedure when you stop spraying and before cleaning, checking, or servicing the equipment.

1. Turn off the fluid supply to the meter or fluid panel.
2. Depending on the Control Method selected (see [Control Method Considerations, page 32](#)), enter a Target Fluid Value of at least 1/2 of maximum (such as, 50%, 50 psi, 200 cc/min, or 12 mA).
 - a. Put the system into Dispense Mode  (see [Run Mode Selection, page 34](#)).
3. Actuate your fluid system dispensing device.
4. Put the system into Standby Mode  (see [Run Mode Selection, page 34](#)).
5. Turn off the vented air supply valve (L).

NOTICE

To avoid damage to the I/P transducer, always put the system into Standby Mode (see [Run Mode Selection, page 34](#)), or power the system off, before reducing air pressure to the system.

Flow Meter Operation

--	--	--	--	--

To reduce the risk of component rupture, which could cause injury from splashing fluid, do not exceed the maximum working pressure of your meter or any component or accessory in your system.

For information on the G3000, S3000, or G250 Graco flow meter, see manual 308778. For information on the Coriolis flow meter, see manual 313599. Calibrate the meter as instructed before using the meter for production.

NOTICE

The flow meter gears and bearings can be damaged if they rotate at too high a speed. To avoid high-speed rotation, gradually open the fluid valve. Do not over-speed the gear with air or solvent. To prolong meter life, do not use the meter above its maximum flow rate.

ADCM Module

Display Information

The Display Module provides the interface for users to enter selections and view information related to setup and operation.

The screen backlight is factory set to remain on, even without screen activity. See [Setup Screen 15: Date and Time, page 53](#), to set the backlight timer to your preference. Press any key to restore.

Keys are used to input numerical data, enter setup screens, navigate within a screen, scroll through screens, and select setup values.

NOTICE

To prevent damage to the softkey buttons, do not press the buttons with sharp objects such as pens, plastic cards, or fingernails.







Operation Modes

The ProControl 1KE Plus has two operation modes: Run Mode and Setup Mode. For detailed information, see [Run Screens, page 34](#), and [Setup Screens, page 43](#). Press  to toggle between these two modes.





Screen Navigation and Editing

Refer to this section if you have questions about screen navigation or about how to enter information and make selections.





All Screens

1. Use   to move between screens.
2. Press  to enter a screen. The first data field on the screen will highlight.
3. Use   to highlight the data you wish to change.
4. Press  to edit.

Drop Down Field



1. Use   to highlight the correct choice from the menu.
2. Press  to select.
3. Press  to cancel.

Number Field

1. The first digit will be highlighted. Use   to change the number.
2. Press  to move to the next digit.
3. When all digits are correct, press  again to accept.
4. Press  to cancel.





Check Box Field

A check box field is used to enable or disable features in the software.

1. Press  to toggle between  and an empty box.
2. The feature is enabled if a  is in the box.

Reset Field

The reset field is used for totalizers. Press  to reset the field to zero.







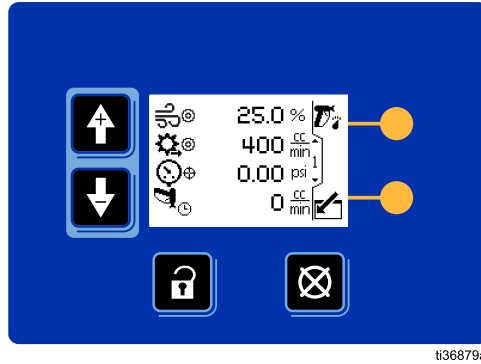





When all data is correct, press  to exit the screen. Then use   to move to a new screen, or  to move between Setup Mode and Run Mode.











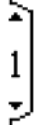
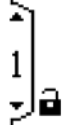







Icons



















As you move through the ProControl 1KE Plus screens, you will notice that most information is communicated using icons rather than words to simplify global communication. The detailed screen descriptions in [Run Screens, page 34](#), and [Setup Screens, page 43](#), explain what each icon represents. Icon reference tables also are provided, on this page and the next. Softkeys are membrane buttons whose function correlates with the screen content to the immediate left of the button.



t136879a

Membrane Keys	Softkeys
 <p>Press to toggle between Run Mode and Setup Mode.</p>	 <p><i>Mode Selection.</i> Opens a menu of Run Mode selections (Run Mode Selection, page 34).</p>
 <p><i>Error Reset:</i> Use to clear alarm after cause has been fixed. Also used to cancel data entered and return to original data.</p>	 <p><i>Enter Screen.</i> Highlight data that can be edited. Also changes the function of the Up/Down arrows so they move between data fields on the screen, rather than between screens.</p>
 <p><i>Up/Down Arrows:</i> Use to move between screens or fields on a screen, or to increment or decrement the digits in a settable field.</p>	 <p><i>Exit Screen.</i> Exit data editing.</p>
 <p><i>Softkeys:</i> Use varies by screen. See column at right.</p>	 <p><i>Enter.</i> Press to activate a field for editing or to accept the highlighted selection on a menu.</p>
	 <p><i>Right.</i> Move to the right when editing number fields. Press again to accept the entry when all digits are correct.</p>
	 <p><i>Reset.</i> Reset totalizer to zero.</p>
	 <p>Start</p>
	 <p>Stop</p>
	 <p><i>Job Log.</i> Saves the current job log data, resets totalizers, and initiates a new job logging cycle.</p>

Screen Icons	
	
Screen number. The arrows indicate more screens are available to view.	Lock icon indicates the unit is in Setup.
	
Batch Totalizer	Batch Units
	
Maintenance Totalizer	Maintenance Target
	
Grand Totalizer	Set Grand Total Units
	
Fluid Flow Percent Target	Fluid Pressure
	
Fluid Flow Rate	Set Modbus Mode
	
Set Modbus Address	Set Serial Port Baudrate
	
Set Serial Port Parity	Modbus Functionality is Off
	
Set Upper and Lower Limits for Fluid Flow Percent	ProControl 1KE is Modbus Slave
	
Set Pressure Units	Set Maximum and Minimum Flow Rates

Screen Icons	
	
Set Flow Rate Units	Maintenance Totalizer Alarm Enable
	
Flow Rate Alarm Enable	Set Alarm Auto Clear (to clear alarm on accessories)
	
Set Backlight Timer	Volume measured by the meter
	
Actual volume dispensed	K-Factor
	
Select Pressure Transducer	Set Zero Offset
	
Display or adjust pressure transducer slope	F3 Flow Rate High Alarm
	
MF Maintenance Alarm	F2 Flow Rate Low Alarm
	
Select Correct Date	Select Date Format
	
Set the Correct Time	Enter User-Set Password

Control Method Considerations

The ProControl 1KE Plus software allows for multiple control methods, which are selected and configured on the Setup screens. The control method you chose will determine the information and options available on the Run Screens.

Control methods are selected on [Setup Screen 13: Control Method, page 52](#).

1. The Control Method setup screen.





2. Select the icon for your control method.



The control method options are described in the following table.

Table 1 Control Methods and Run Screen Examples

Selection Icon	Description and Typical Application	Run Screen Examples
	<p>Monitor and Accumulate Volume Only</p> <p>No active control. The system drives to the setpoint immediately, and will not adapt to changes in pressure or flow.</p>	
	<p>ADCM Only</p> <p>An ADCM that is not configured with specific pressure sensors, flow meters, or output controls has limited capabilities on the run screen. However, all of the system setup screens are still available for offline configuration.</p>	
	<p>Closed-Loop Pressure Control</p> <p>Drives to a fluid pressure target, and may monitor flow. The system drives to the setpoint using the PID control. It will not adapt to changes in flow.</p>	

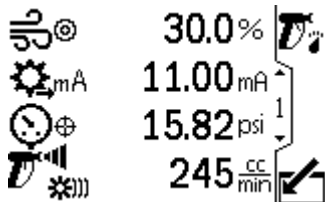
Selection Icon	Description and Typical Application	Run Screen Examples
	<p>Closed-Loop Flow Control</p> <p>Drives to a fluid flow target. The system drives to the setpoint using a PID control for pressure, which is targeting from the PID control for flow.</p>	
<p>0-32mA</p>	<p>Current Setpoint to Pilot Air Control</p> <p>For testing and setup. The system drives to the current output immediately.</p> <p>Note</p> <p>4–20 mA approximately corresponds to 0–100 psi (0–6.9 bar) pilot air pressure.</p>	

Systems without the atomizing air control option do not have a separate control to enable it. The setting

will remain on the screen. Leave the atomizing air setpoint at 0 in that case.



Run Screens



Screen 1: Run Operations

Run Mode Selection

There are four Run modes that can be selected from the Run screen.

1. Press the softkey next to the Mode Selection  icon.
2. Select one of the following mode icons from following table.

Icon	Description
	Standby Mode – depressurize system <ul style="list-style-type: none"> • Gun atomizing air pressure is set to 0 • Fluid pressure is set to 0
	Flush Mode – used for solvent flush <ul style="list-style-type: none"> • Gun atomizing air pressure is set to 0 • Fluid pressure is set to a percent value (see Setup Screen 12: Flush Mode, page 52)



Icon	Description
	Fill Mode – used for loading paint <ul style="list-style-type: none"> • Gun atomizing air pressure is set to 0 • Fluid pressure is set to a percent value (see Setup Screen 11: Fill Mode, page 51)
	Dispense Mode – used for painting <ul style="list-style-type: none"> • Gun atomizing air pressure is set to the target percent value • Fluid pressure is set to either the flow or pressure target
	Dispense Mode – gain reset <ul style="list-style-type: none"> • This is used to put the system back into “high gain” mode where it will rapidly attempt to correct any off-target flow situation.

Standby Mode Operation





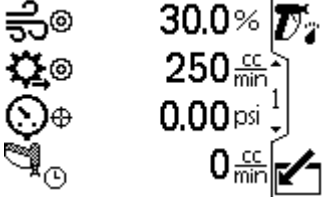
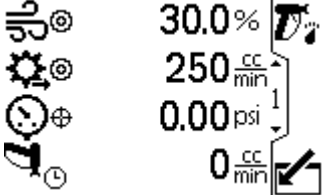





In Standby Mode, the atomizing air and the fluid pressure pilot regulators are set to zero (0). The flow meter remains operational, and the system will show fluid flow and accumulated fluid volume. Residual pressure may be in the system depending on the nature of the air and fluid regulators, material properties, and other variances.

When the system is first powered up, the type of fluid in the system is unknown. This is indicated with checkerboard pattern on the gun. After a fluid Fill process, the gun is shown as black to indicate that it is loaded with sprayable material. After a fluid Flush process, the gun is shown as white to indicate that it is loaded with solvent.

Table 2 Standby Mode Run Screens

Description	Examples
Standby after power-up with an unknown fluid	
Standby with paint loaded	
Standby with solvent loaded	

The following icons are available on the Run Screen in Standby Mode:

Key	
	Enter the screen.
	Atomizing air regulator
	Flow rate target (Closed Loop Flow Control Mode)
	% pilot air pressure target to fluid regulator
	Pressure target (Closed Loop Pressure Mode)
	Current (mA) setpoint to pilot air control
	Current fluid pressure
	Standby Mode – Unknown fluid in system
	Standby Mode – System filled with sprayable material
	Standby Mode – System filled with solvent
	Move between Run Screens.

Flush Mode Operation

The data used to operate Flush Mode is configured in [Setup Screen 12: Flush Mode, page 52](#).

When Flush Mode is activated, the fluid regulator is set to the percentage drive value from the setup screen. The atomizing air regulator is set to zero. This runs for the selected amount of time. The fluid volume that flowed during the flush process is compared to the minimum flush volume from the setup screen. If the volume was not achieved, the “SP” alarm is activated. The fluid volume is tracked as a solvent in the Job Log.

Table 3 Flush Mode Run Screens

Description	Examples
Flush Mode active	
Flush Mode complete	

The following icons are available on the Run Screen in Flush Mode:









Key	
	Enter the screen.
	Atomizing air regulator
	Flow rate target
	Current fluid pressure
	Flush Mode – No flow detected
	Flush Mode Countdown Timer
	Move between Run Screens.

Fill Mode Operation







The data used to operate Fill Mode is configured in [Setup Screen 11: Fill Mode, page 51](#).

When Fill Mode is activated, the fluid regulator is set to the percentage drive value from the setup screen. The atomizing air regulator is set to zero. This runs for the selected amount of time. The fluid volume that flowed during the fill process is compared to the minimum fill volume from the setup screen. If the volume was not achieved, the “SN” alarm is activated.

Table 4 Fill Mode Run Screens

Description	Examples
Fill Mode active	     30.0% 250 ^{cc} / _{min} 18.16 psi 229 ^{cc} / _{min}
Fill Mode complete	    30.0% 250 ^{cc} / _{min} 0.00 psi 0 ^{cc} / _{min}

The following icons are available on the Run Screen in Fill Mode:

Key	
	Enter the screen.
	Atomizing air regulator
	Flow rate target
	Current fluid pressure
	Fill Mode – No flow detected
	Fill Mode Countdown Timer
	Move between Run Screens.

Dispense Mode Operation

When Dispense Mode is activated, the fluid regulator is opened and adjusted based on the control method. The atomizing air regulator is opened to the setpoint. The gun icon has several animation sequence components to indicate conditions of the gun trigger and fluid flow.

If the System Idle function is activated in [Setup Screen 9: Additional Operator Input Limits and Timeouts, page 50](#), then if the gun trigger is not activated after the amount of time selected the system fluid pressure will be reduced to zero (0). The “EU” event is activated. The Atomizing air pressure remains at the setpoint. Once the gun trigger is activated again, fluid pressure is returned to the setpoint, and Dispense mode resumes. Note that repressurizing the system takes some time, so fluid and spray dynamics may be different for the first few seconds of operation compared to a typical gun triggering cycle.

If the Dose Time function is activated in [Setup Screen 9: Additional Operator Input Limits and Timeouts, page 50](#), then if there is no fluid flow while the gun trigger is activated after the amount of time selected on the screen the fluid pressure will be reduced to zero. The “QT” alarm is activated. The system is returned to Standby Mode. To return to Dispense Mode, determine and repair the cause of no fluid flow, clear the alarm, and reactivate the mode.

Table 5 Dispense Mode Run Screens

Description	Examples
Dispense Mode with no gun trigger	
Dispense Mode with atomizing air, no fluid flow	

Description	Examples
Dispense Mode with no atomizing air, fluid flowing	
Dispense Mode with atomized spray (air and fluid flow)	









The following icons are available on the Run Screen in Dispense Mode:

Key	
	Enter the screen.
	Atomizing air regulator percent open target
	Flow rate target
	% pilot air pressure target to fluid regulator
	Pressure target (Closed Loop Pressure Mode)
	Current (mA) setpoint to pilot air control
	Current fluid pressure
	Dispense Mode idle with AFS off
	Dispense Mode active with air flow only
	Dispense Mode active with fluid flow only
	Dispense Mode active with fluid and air flow
	Dispense Mode during System Idle
	Dispense Mode during Dose Time
	Move between Run Screens.







Screen 2: Job Log Totalizer

This is the active Job Log screen. This totalizes the dispensed amounts of paint and solvent per job. It is tracked by job number, and includes an additional user-defined job identification number; station, part, or other code.

Table 6 Job Log Totalizer Screen



Description	Examples
Sample totalizers	 242.7 cc   155.4 cc   000000132   000100903 

The following icons are available on the Job Log screen:



Key	
	Enter the screen
	Job Spray Totalizer
	Job Flush Totalizer
	Job Log – saves current job log data, resets totalizers, and initiates a new job logging cycle
	Job Number – increments automatically
	Job Identification Number – user-assigned
	Move between Run Screens

Job Log Data and Functions



Paint Dispense Total

The paint dispense totalizer () accumulates the total amount of fluid dispensed in the job logging cycle. This is reset to zero when the Job Log icon () is pressed. This includes fluid from the Fill cycle, including any unsprayed paint in the hose.

Solvent Dispense Total

The solvent dispense totalizer () accumulates the total amount of fluid dispensed in the job logging cycle. This is reset to zero when the Job Log icon () is pressed. This only includes fluid from the Flush cycle.

Job Number Setting

The job number () is automatically assigned in increments, though it can be set at any time. When the Job Log icon () is pressed, "1" is added to this value.

Identification Number Setting

The job identification number () does not change automatically, and can be set at any time. The same number will be logged with each job.

Job Finalization

The job is completed and stored when the Job Log icon () is pressed.

Screen 3: Job Log History

This displays information from the stored job logs.

Table 7 Job Log History Screen

Description	Examples
Job log history data	

The following icons are available on the Job Log History screen:

Key	
	Enter the screen.
	Job Index
	Year
	Date
	Time
	Job Number
	Job Identification Number
	Job Spray Totalizer
	Job Flush Totalizer
	Move between Run Screens.

Job Log History Data

Job Index

Index of logged jobs. The most recent job, which is always index “000”, is initially displayed when the screen is entered; the lower the index, the more recent the job. The Job

Index () can be set directly by entering the number field and selecting a value from “000” to “500” to quickly jump to any record, or the value can be incrementally increased or decreased using the keyboard arrow keys.

Year, Date, and Time

The Year (), Date (), and Time () the job was completed.

Job Number

The Job Number () active when the job was logged.

Job Identification Number

The Job Identification Number () active when the job was logged.

Paint Total

The total volume of paint () dispensed.

Solvent Total

The total volume of solvent () dispensed.

Screen 4: Event Log History

This displays information from the stored event logs.

Table 8 Event Log History Screen

Description	Examples
Event log history data	

The following icons are available on the Event Log History screen:

Key	
	Enter the screen.
	Event Index
	Year
	Date
	Time
	Threshold
	Outlier
	Advisory
	Deviation
	Alarm
P2	Event Code
Low Pressure	Event Description
	Move between Run Screens.

Event Log History Data

Job Index

Index of logged events. The most recent event, which is always index "000", is initially displayed when the screen is entered; the lower the index, the more recent the event. The Event Index () can be set directly by entering the number field and selecting a value from "000" to "500" to quickly jump to any record, or the value can be incrementally increased or decreased using the keyboard arrow keys.

Year, Date, and Time

The Year (, ³⁵365), Date (, 07/29), and Time (, 13:18:50) the event was completed.

Limit Threshold

The Threshold (, ↑) of the alarm.

Outlier Value

The measured value of the Outlier (, 10.01) that exceeds the threshold of the alarm.

Event Type

Events can be Deviations (, P2), Advisories (, Low Pressure), or Alarms (). Some events have a fixed type, while others can be selected depending on user preferences. See [Deviations and Advisories, page 56](#).

Event Code

The Event Code. See [Deviations and Advisories, page 56](#).





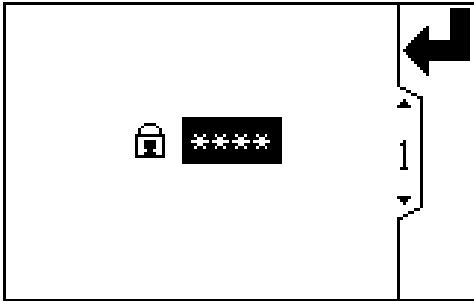

Event Description

A short description of the Event Code.

Password Screen

If a password has been set, the Password Screen displays when  is pressed from any Run screen. Enter password to enable entry to the Setup screens. Set the password to 0000 to disable password protection. See [Setup Screen 16: Password, page 54](#), to set or change the password.



Key	
	Enter the screen to enter a password.
	Press to activate a field for editing.
	Move to the right when editing number fields. Press again to accept the entry when all digits are correct.
	Enter the user-set password for the system.
 	Increment/decrement the digits when editing number fields.

Setup Screens

The Setup Mode is used to set up a password (if desired) and to set parameters for controlling and monitoring fluid flow with the ProControl 1KE Plus.

See [Screen Navigation and Editing, page 29](#), for information on how to make selections and enter data.





Setup Screen 1: Job Target

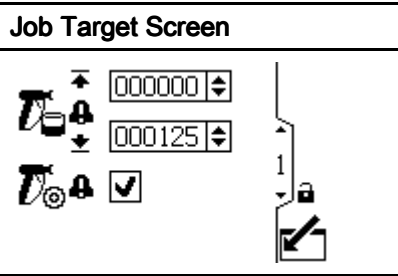
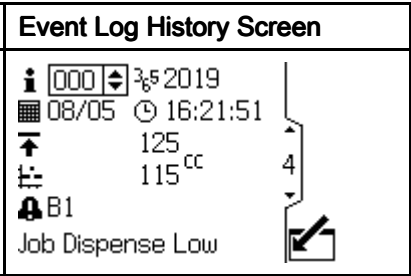
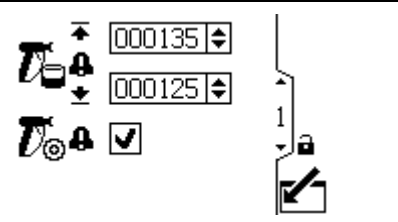
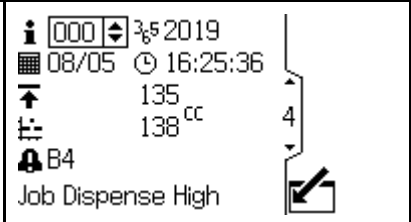

The Job Target screen is used to monitor the range of sprayed fluid per job. When a job is logged, and

the dispensed volume is outside the limit, the alarm will be turned on. A limit value of 0 turns off the alarm.

Table 9 Job Target Examples

Description	Job Target Screen	Event Log History Screen
Example with a minimum volume of 125 cc. The logged job was 115 cc, so the alarm was activated.		
Example with a range from 125 cc to 135 cc. The logged job was 138 cc, so the alarm was activated.		

Key	
	Enter the screen to set or change preferences.
	Press to activate a field for editing or to accept the highlighted selection on a menu.
	Move to the right when editing number fields. Press again to accept the entry when all digits are correct.
	Job dispense alarm range.

Key	
	Job dispense alarm enable (✓).
	Exit data editing.
	Move between Setup Screens, fields on a screen, or to increment/decrement the digits when editing number fields.

Setup Screen 2: Maintenance Totalizer

Use this screen to view and reset the maintenance totalizer, and set the maintenance target value.

Maintenance totalizer units, shown on this Setup Screen, are always cubic centimeters (cc).

Table 10 Maintenance Totalizer Screen

Description	Example
No data or selections.	
Example with the maintenance level set to 100 cc and the alarm enabled. Once 100 cc is reached, the “MF” alarm is activated.	
Clear the alarm by entering the screen, selecting the Reset option, and selecting the Clear Alarm button.	

Key	
	Enter the screen to set or change preferences.
	Press to activate a field for editing or to accept the highlighted selection on a menu.
	Move to the right when editing number fields. Press again to accept the entry when all digits are correct.
	Reset Maintenance Totalizer - resets the maintenance totalizer to zero.
	Maintenance Totalizer - Displays the current maintenance total in cubic centimeters (cc).

Key	
	Set your desired maintenance total target value in this field in cubic centimeters (cc).
	Maintenance Totalizer Alarm Enable (M).
	Exit data editing.
	Move between Setup Screens, fields on a screen, or to increment/decrement the digits when editing number fields.

Setup Screen 3: Grand Totals

Use this screen to view the Grand Total volumes and to set the Grand Total units.

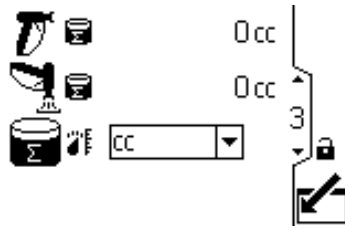

Key	
	Enter the screen to set or change preferences.
	Press to activate a field for editing or to accept the highlighted selection on a menu.
	Move to the right when editing number fields. Press again to accept the entry when all digits are correct.
	Grand Total for Spray Material
	Grand Total for Flush Material
	Volume Units – Select from the following options: none – Select if system has no flow meter cc L gal
	Exit data editing.
	Move between Setup Screens, fields on a screen, or to increment/decrement the digits when editing number fields.

Setup Screen 4: Calibration

Use this screen to calibrate your meter and to view or set your meter k-factor. See [Calibrate the Meter, page 55](#), for procedure.









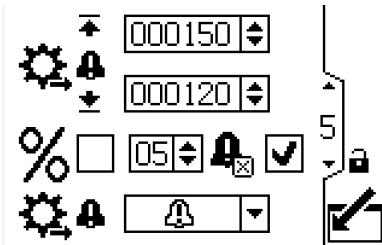





Key	
	Enter the screen to set or change preferences.
	Press to activate a field for editing or to accept the highlighted selection on a menu.
	Move to the right when editing number fields. Press again to accept the entry when all digits are correct.
	Start the calibration.
	Stop the calibration.
	Displays the volume measured by the system for the calibration test.
	Enter the actual volume dispensed into the cylinder for the calibration test.
	Displays the meter k-factor. User can set the k-factor manually. The system automatically updates to the correct k-factor when the meter is calibrated.
	Flow Rate Units – Select from the following options: none – Select if system has no flow meter cc/min L/min gal/min
	Exit data editing.
	Move between Setup Screens, fields on a screen, or to increment/decrement the digits when editing number fields.

Setup Screen 5: Flow Rate

Use this screen to set your flow rate maximum and minimum alarm values.



Key	
	Enter the screen to set or change preferences.
	Press to activate a field for editing or to accept the highlighted selection on a menu.
	Move to the right when editing number fields. Press again to accept the entry when all digits are correct.
	Set your desired maximum (first data field) and minimum (second data field) flow rates. Flow rates outside of these parameters will trigger an alarm.
	Select <input checked="" type="checkbox"/> if you want the alarm to be based on percent deviation from the current active target flow rate. When selected, the maximum and minimum values shown above will automatically update based on the selected +/- percent amount and the current active Flow Rate Target on the Run Screen.

Key	
	Set the +/- percent difference from the flow target that will trigger an alarm.
	Alarm Auto Clear Enable. If enabled, when the flow rate returns to within the flow limit set points, the flow rate alarm will clear on the screen and on any attached accessories such as a light tower.
	Select the type of alarm.
	Advisory. System does not shut down. It does not attempt to modify operation. Event is logged.
	Deviation. System does not shut down. It may attempt to modify operation to adjust to the conditions. Event is logged.
	Alarm. System shuts down. Event is logged.
	Exit data editing.
	Move between Setup Screens, fields on a screen, or to increment/decrement the digits when editing number fields.

Setup Screen 6: Pressure Transducer

Use this screen to specify your pressure transducer and set its offset and slope.

Table 11 Setup Screen 6

Description	Examples
Empty	
With data	

Key	
	Enter the screen to set or change preferences.
	Press to activate a field for editing or to accept the highlighted selection on a menu.
	Move to the right when editing number fields. Press again to accept the entry when all digits are correct.
	Select the correct pressure transducer. <ul style="list-style-type: none"> • (None) • 100 psi • 2000 psi • 4500 psi
	Pressure transducer slope. This number is a constant representing millivolts per bar. The default matches the selected pressure transducer. Operator adjustable. Default value is "090.000".
	Set the zero offset (the reading on the gauge when no pressure is on the system). Default value is "00.4500".
	Select units.
	Exit data editing.
	Move between Setup Screens, fields on a screen, or to increment/decrement the digits when editing number fields.

Setup Screen 7: Pressure

Use this screen to set your pressure maximum and minimum alarm values, and to select your preferred units.



Key	
	Enter the screen to set or change preferences.
	Press to activate a field for editing or to accept the highlighted selection on a menu.
	Move to the right when editing number fields. Press again to accept the entry when all digits are correct.
	Set your desired maximum (first data field) and minimum (second data field) pressure. Pressures outside of these parameters will trigger an alarm.
	Select <input checked="" type="checkbox"/> if you want the alarm to be based on percent deviation from the current active target pressure. When selected, the maximum and minimum values shown will automatically update based on the selected +/- percentage and the current active target pressure on the Run screen.

Key	
	Set the +/- percent difference from the pressure target that will trigger an alarm.
	Alarm Auto Clear Enable. If enabled, when the pressure returns to within the pressure limit set points, the pressure alarm will clear on the screen and on any attached accessories such as a light tower.
	Select the type of alarm.
	Advisory. System does not shut down. It does not attempt to modify operation. Event is logged.
	Deviation. System does not shut down. It may attempt to modify operation to adjust to the conditions. Event is logged.
	Alarm. System shuts down. Event is logged.
	Exit data editing.
	Move between Setup Screens, fields on a screen, or to increment/decrement the digits when editing number fields.

Setup Screen 8: Operator Input Limits

This screen changes format and data based on the Control Method. See [Control Method Considerations, page 32](#), for more information.

The following table demonstrates how operator input limits may be set for the setpoints on the Run screen.

Note

These are not alarm limits.

Table 12 Setup Screen 8 Operator Input Limit Examples by Control Method

Description	Setup Screen 8 Example	Run Screen Example
Monitor and Accumulate Volume Only		
Closed-Loop Pressure Control		
Closed-Loop Flow Control		
Open-Loop Current Setpoint	Note There are no input limits for the Open-Loop Current Setpoint method.	

Key	
	Enter the screen to set or change preferences.
	Press to activate a field for editing or to accept the highlighted selection on a menu.
	Move to the right when editing number fields. Press again to accept the entry when all digits are correct.
	Set your desired maximum (first data field) and minimum (second data field) pressure when in pressure control mode. The system's Pressure Target will not be allowed to be set outside of this range.

Key	
	Set your desired maximum (first data field) and minimum (second data field) flow rate when in flow control mode. The system's Flow Rate Target will not be allowed to be set outside of this range.
	Exit data editing.
	Move between Setup Screens, fields on a screen, or to increment/decrement the digits when editing number fields.

Setup Screen 9: Additional Operator Input Limits and Timeouts

This screen contains the Atomization Air percentage input limits, the System Idle timeout, and the Dose Time timeout.

Table 13 Setup Screen 6

Description	Examples
Empty	
With data	

Key	
	Enter the screen to set or change preferences.
	Press to activate a field for editing or to accept the highlighted selection on a menu.
	Move to the right when editing number fields. Press again to accept the entry when all digits are correct.
	Set your desired maximum (first data field) and minimum (second data field) atomizing air percentage. The system's atomizing air setpoint cannot be set outside of this range.
	The number of minutes with the system in Dispense mode with no gun trigger activation before it sets the fluid regulator to zero. Once the gun trigger is activated the regulator will be driven to the previous value.
	The number of seconds with the system in Dispense mode with no detected fluid flow while the gun trigger is activated. The alarm will shut down the system.
	Exit data editing.
	Move between Setup Screens, fields on a screen, or to increment/decrement the digits when editing number fields.

Setup Screen 10: PID Data

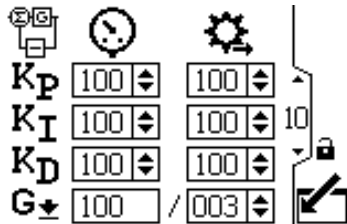

Key	
	Enter the screen to set or change preferences.
	Press to activate a field for editing or to accept the highlighted selection on a menu.
	Move to the right when editing number fields. Press again to accept the entry when all digits are correct.
	Pressure control loop.
	Flow control loop.
K_P	Proportional gain.
K_I	Integral gain.
K_D	Derivative gain.
G_{\downarrow}	<p>First box displays the current gain the system is operating, this number will decrease as they system approaches its flow target and will increase if the flow diverges from target.</p> <p>The second box is editable and is the lowest gain the system will use. Higher numbers will increase sensitivity but may cause errors in certain situations such as gun feathering and very short trigger times.</p>
	Exit data editing.
	Move between Setup Screens, fields on a screen, or to increment/decrement the digits when editing number fields.

Setup Screen 11: Fill Mode

Use this screen to set up the parameters for Fill Mode. When set, the Minimum Fill Volume is checked against the amount of material that flowed during the Fill process. The “SN” Minimum Fill Volume alarm is set if this isn’t achieved. Selection of Dispense Mode is not allowed until the programmed Minimum Fill Volume is reached.

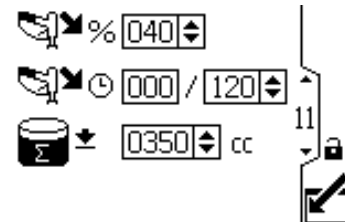

Key	
	Enter the screen to set or change preferences.
	Press to activate a field for editing or to accept the highlighted selection on a menu.
	Move to the right when editing number fields. Press again to accept the entry when all digits are correct.
	Set fluid regulator to a percentage open.
	Set a fill duration time. The first box displays the remaining time when a Fill Mode is active.
	Minimum Fill Volume. Set to “0” to disable this feature.
	Exit data editing.
	Move between Setup Screens, fields on a screen, or to increment/decrement the digits when editing number fields.

Setup Screen 12: Flush Mode

Use this screen to set up the parameters for Flush Mode. When set, the Minimum Flush Volume is checked against the amount of material that flowed during the Flush process. The “SP” Minimum Flush Volume alarm is set if this isn’t achieved.

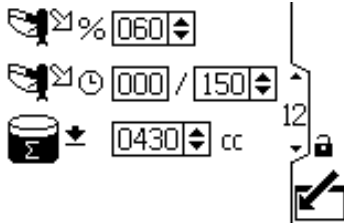

Key	
	Enter the screen to set or change preferences.
	Press to activate a field for editing or to accept the highlighted selection on a menu.
	Move to the right when editing number fields. Press again to accept the entry when all digits are correct.
	Set fluid regulator to a percent open. The first box displays the remaining time when a Flush Mode is active.
	Set a flush duration time.
	Minimum Flush Volume. Set zero to disable this feature
	Exit data editing.
	Move between Setup Screens, fields on a screen, or to increment/decrement the digits when editing number fields.

Setup Screen 13: Control Method

Use this screen to set the system control method. See [Control Method Considerations, page 32](#), for more information.

Table 14 Setup Screen 13

Description	Examples
With control method selected	
With selection menu open	

Key	
	Enter the screen to set or change preferences.
	Press to activate a field for editing or to accept the highlighted selection on a menu.
	Move to the right when editing number fields. Press again to accept the entry when all digits are correct.
	Control Method selection.
	Scaled percentage of the 4mA to 20mA range of the control valve.
	Direct pressure setpoint for closed-loop control.
	Direct flow rate setpoint for closed-loop control.
0-32mA	Direct milliamp output selection to the control valve.
	Exit data editing.
	Move between Setup Screens, fields on a screen, or to increment/decrement the digits when editing number fields.

Setup Screen 14: Modbus

Use this screen to set your Modbus preferences for ports 1 and 2. Note that ports 5 and 6 are used as Modbus master devices for connecting to other ProControl 1KE, Informer, or Graco Integrated Paint Kitchen modules.

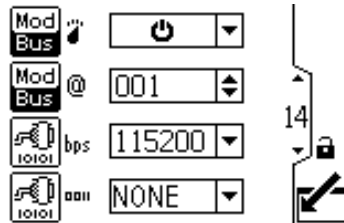

Key	
	Modbus mode. Select off or Slave from the menu options. Turn off Modbus functionality if not used. Use ProControl 1KE as Modbus slave device.
	Enter or change the Modbus address. Value is between 1 and 247.
	Select serial port baudrate from the menu options: 9600, 19200, 38400, 57600, or 115200.
	Select serial port parity from the menu options: NONE, ODD, or EVEN.
	Exit data editing.
	Move between Setup Screens, fields on a screen, or to increment/decrement the digits when editing number fields.

Setup Screen 15: Date and Time

Use this screen to set your date format, date, time, and backlight timeout.







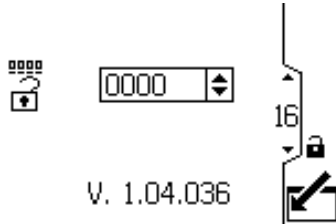

Key	
	Enter the screen to set or change preferences.
	Press to activate a field for editing or to accept the highlighted selection on a menu.
	Move to the right when editing number fields. Press again to accept the entry when all digits are correct.
	Select your preferred date format from the menu. MM/DD/YY DD/MM/YY YY/MM/DD
	Set the current date.
	Set the current time.
	Backlight timeout in minutes. Set zero to disable backlight timeout.
	Exit data editing.
	Move between Setup Screens, fields on a screen, or to increment/decrement the digits when editing number fields.

Setup Screen 16: Password

Use this screen to enter a password that will be required to access the Setup screens. This screen also displays the software version.



Key	
	Enter the screen to set the password.
	Press to activate the field for editing.
	Move to the right when editing number fields. Press again to accept the entry when all digits are correct.
	Enter desired password. Enter "0000" to disable the password.
	Exit data editing.
	Move between Setup Screens, fields on a screen, or to increment/decrement the digits when editing number fields.

Calibrate the Meter

NOTE: See [Setup Screen 4: Calibration, page 45](#), for further screen information, if needed.







When to Calibrate





- The first time the system is operated.
- Whenever new materials are used in the system, especially if the materials have viscosities that differ significantly.
- As part of regular maintenance to retain meter accuracy.
- Whenever a flow meter is serviced or replaced.





Read Before Calibration

- Meter k-factor on [Setup Screen 4: Calibration, page 45](#), is updated automatically after the calibration procedure is completed. You also may manually edit the k-factor if desired.
- All values on this screen are in cc or cc/pulse, regardless of the units set in the other Setup screens.
- Before calibrating the meter, be sure the system is primed with material.
- Disable alarms before calibration.



Calibration Steps

1. Press  to enter Setup Mode.
2. Press  to move to Setup Screen 4.
3. Press  to enter the screen.
4. Press  to begin the calibration.
5. Dispense about 300–500 cc of material into a graduated cylinder. The amount the system measures will display in the measured volume field .
6. Press  to end the calibration.

7. Press  to get to the dispensed volume field , then press  to enter the field. Enter the amount of material in the cylinder.
8. After the volume is entered, the system calculates the new k-factor  and shows it on Setup Screen 4.

NOTE: To clear the counter and begin the calibration again, press , move briefly to another screen, then return to Setup Screen 4 and start over. If you press  without leaving the screen, the counter will continue from where it is, without clearing.
9. Press  to exit the screen.
10. Press  to exit Setup Mode.

Set the Modbus Addresses



See **Setup Screen 11**. By default, the Modbus is set to Off . If you need the Modbus, set the Modbus mode to SLAVE . The address value is between 1 and 247. The modbus address corresponds to the address of the ProControl 1KE Plus. See [Appendix A - Modbus Variable Map, page 81](#), for more information.

Update the Software

Software updates are installed using a software token (PN 25B324). Manual 3A1244 will accompany any necessary software updates. Follow all instructions and warnings in Manual 3A1244 to update your ProControl 1KE Plus software.

Deviations and Advisories

There are three types of events that can occur. Events are indicated on the display by alternately flashing between the event code and the event icon.

- Alarms, indicated by , will stop the system. Fluid and atomizing air pressures are set to zero, and the system is returned to Standby mode.
- Deviations, indicated by , require attention but will not stop the system.
- Advisories, indicated by , will not stop the system.

If multiple events are active, the display will cycle through the events at the highest priority level. For instance, if F3, P3, and MF are all active, the display will cycle between only F3 and P3.

Alarm Log Logic: (Available for Flow and Pressure Alarms only) If Alarm Auto Clear is enabled, the system will not log the same alarm twice. For example, if the system goes back and forth between









low flow (F2) and normal, the system will log this error only once to keep the log from filling up before the operator corrects the condition.





















If Alarm Auto Clear is not enabled, each alarm will log only once if the operator corrects the condition and then clears the alarm. The alarm will log twice if the operator clears the alarm before correcting the condition.

Note

In Pressure Control or Flow Control mode, the setpoint target is not modified to keep system within the F2 and F3 range configured in [Setup Screen 5: Flow Rate, page 46](#), or within the P2 and P3 range configured in [Setup Screen 7: Pressure, page 48](#). The alarms conditions are monitored independently of the control system.

The following table explains the error type that is associated with each error code and icon. Press  to clear alarm after the cause has been addressed.

Deviations and Advisories				
Code	Icon	Summary	Description	Solution
F3		High Flow	Selectable event level. Active when the flow rate is higher than the user-set maximum for one second.	Adjust flow rate, maximum flow limit, or disable alarm (Setup Screen 5: Flow Rate, page 46). Press  to clear alarm. The alarm will not clear until the flow rate is within limits.
F2		Low Flow	Selectable event level. Active when the flow rate is lower than the user-set minimum for a variable time depending on operating conditions.	Adjust flow rate, minimum flow limit, or disable alarm (Setup Screen 5: Flow Rate, page 46). Press  to clear alarm. The alarm will not clear until the flow rate is within limits.
P3		High Pressure	Selectable event level. Active when the fluid pressure is higher than the user-set maximum for one second.	Adjust pressure, maximum pressure limit, or disable alarm (Setup Screen 7: Pressure, page 48). Press  to clear alarm. The alarm will not clear until the pressure is within limits.
P2		Low Pressure	Selectable event level. Active when the fluid pressure is lower than the user-set minimum for one second.	Adjust pressure, minimum pressure limit, or disable alarm (Setup Screen 7: Pressure, page 48). Press  to clear alarm. The alarm will not clear until the pressure is within limits.
QT		Dose Time	Alarm only. Active when the gun trigger is activated but no fluid flow is detected.	Determine cause of fluid flow stoppage.

Deviations and Advisories				
Code	Icon	Summary	Description	Solution
SN		Minimum Fill Volume	Alarm only. Active when the user-set fill volume is not achieved in a fill cycle.	Increase fill drive percentage, fill time, or check fluid supply (Setup Screen 10: PID Data, page 51). Press  to clear alarm.
SP		Minimum Flush Volume	Alarm only. Active when the user-set flush volume is not achieved in a flush cycle.	Increase flush drive percentage, flush time, or check fluid supply (Setup Screen 11: Fill Mode, page 51). Press  to clear alarm.
B4		Job Dispense High	Alarm only. Active when the logged job spray volume is more than the threshold setpoint.	Adjust flow rate, spray time, maximum volume limit, or disable alarm (Setup Screen 1: Job Target, page 43). Press  to clear alarm.
B1		Job Dispense Low	Alarm only. Active when the logged job spray volume is less than the threshold setpoint.	Adjust flow rate, spray time, minimum volume limit, or disable alarm (Setup Screen 1: Job Target, page 43). Press  to clear alarm.
F6		Runaway Flow	Deviation only. Active when using flow control and the flow target is not achievable.	Determine cause of fluid control failure. Press  to clear alarm.
P6		Runaway Pressure	Deviation only. Active when using pressure or flow control and the pressure target is not achievable.	Determine cause of fluid control failure. Press  to clear alarm.
EU		System Idle	Advisory only. Active when in Dispense mode and the gun trigger has not been activated for the user-set timeout time. Fluid pressure is dropped to zero.	Dispense pressure will resume immediately once the gun trigger is activated. The advisory will automatically clear. Press  to clear alarm.
MF		Maintenance Counter	Advisory only. Active when the maintenance totalizer reaches the user-set maintenance target.	Perform  maintenance. Reset to zero using  (Setup Screen 2: Maintenance Totalizer, page 44). Press  to clear alarm.
G2		Gun Off Setpoint	Advisory only. The flow rate setpoint was changed to a lower value while the gun was off. Instead of predicting a pressure target, the system will predict a current output target to the I/P. It may take extra time to stabilize in this situation.	Activate spraying. Press  to clear alarm.

Troubleshooting

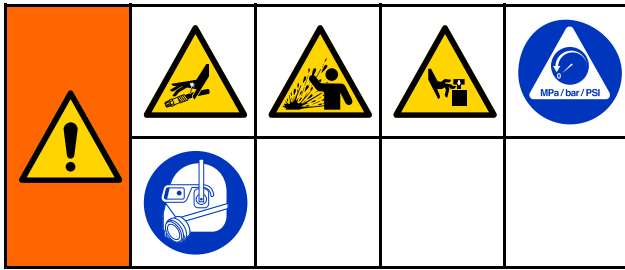

Problem	Cause	Solution
ProControl 1KE Plus is completely dark.	Power is not on.	Turn power supply on.
	Loose or disconnected power cable.	Tighten or connect cable.
ProControl 1KE Plus has power but does not function.	Hardware failure.	Replace ProControl 1KE Plus.
Pressure or Flow Rate reads 0 when fluid is flowing.	Loose or disconnected flow meter/pressure transducer cable.	Check the digital input/output cable going to/from the meter.
Pressure or Flow Rate reads “— — —” all the time.	Units in Setup are set to NONE, indicating that the system has no pressure transducer and/or fluid meter.	Choose preferred units for each device present. See Setup Screen 6: Pressure Transducer, page 47 , for pressure, Setup Screen 4: Calibration, page 45 , for flow rate.
Inaccurate flow reading.	Faulty flow meter sensor or meter.	Replace sensor or meter.
	Meter needs calibration.	Calibrate meter. See Calibrate the Meter, page 55 .
Inaccurate pressure range.	Wrong transducer is selected.	Choose the correct transducer from the options in Setup Screen 6: Pressure Transducer, page 47 .
	Offset or slope are set incorrectly.	Review and correct settings for the pressure offset (mV) and slope (mV/bar). See Setup Screen 6: Pressure Transducer, page 47 .
Display readout faulty.	Excessive static discharge.	Replace ProControl 1KE Plus.
	Ambient temperature too high.	Lower ambient temperature.
Communication failure.	Incorrect data addresses.	Check address configuration.
	Incorrect communication parameters.	Check communication parameters.
	Incorrect cabling.	Check cabling and wiring. See Installation, page 19 .
Fluid is not flowing.	Clogs in fluid line or in meter.	Clean fluid line and/or meter. Consult meter manual (see Related Manuals, page 2).
	Gears worn or damaged.	Service meter. Consult meter manual (see Related Manuals, page 2).

Low flow.	Inadequate air supply through the I/P transducer.	Increase incoming air pressure.
Flow control no settling to setpoint.	Pressure or flow PID K-Factors are not tuned.	See Setup Screen 10: PID Data, page 51 .
Flow control over-driving to high flow rates.	Gun Trigger signal not synchronized with fluid flow valve.	For automatic operation, verify the pressure switch electrical connection. Check that the switch closes when the gun fluid solenoid is activated.
		For manual operation, verify the air flow switch electrical connection. Check that the switch closes when the gun trigger is activated.
		The flow control may activate when the atomizing air is flowing without any fluid flow. <ul style="list-style-type: none"> • If this is because of a dusting procedure, the flow control may over-drive the fluid pressure until it can converge. • If this is because of system startup, this is normal and the flow control should eventually react.
Higher fluid pressure cannot be achieved.	Low fluid pressure after the fluid regulator.	Check incoming system air pressure. This should be at least 10 psi (0.7 bar) higher than the target fluid pressure.
		Check incoming fluid pressure from pump. This should be at least 10 psi (0.7 bar) higher than the target fluid pressure. The pump must be able to supply this pressure at the target flow rate.
		Check I/P pilot line output pressure.
		Check power output of the barrier that powers the system. At 20 mA, for 100 psi (6.9 bar), this should be at least 13.5 volts.
Unstable flow with Coriolis meter.	Presence of bubbles or sediment.	Check for upwards settling of air bubbles.
		Check for downwards settling of solids, such as metallics.
		Consult the Coriolis Meter manual (see Related Manuals, page 2).
Coriolis meter shows flow when no fluid is flowing.	Low-flow cutoff may be set too low.	Increase the low-flow cutoff to just above the highest false flow rate that was observed.
Regulator pilot drives to high pressure.	Inadequate fluid supply in pressure control or flow control mode.	Check pressure and flow capabilities of the fluid supply.

Diagnostic Information



The LEDs on the bottom of the ProControl 1KE give important information about system function.

LED Signals

Signal	Description
Green On	ProControl 1KE Plus is powered up.
Yellow	Internal communication in progress.
Red solid	ProControl 1KE failure. See Troubleshooting.
Red flashing	Software is updating.
Red flashing slowly	Token error; remove token and upload software token again.

Battery Replacement Procedure

Replace the battery only if the clock stops functioning after disconnecting power or a power failure.

				
<p>Sparking can occur when changing the battery. Replace the battery only in a non-hazardous location, away from flammable fluids or fumes.</p>				

NOTICE
<p>To avoid damage to the circuit board, wear Part No. 112190 grounding strap, and ground appropriately.</p>

1. Disconnect power.
2. Remove the module from the bracket.
3. Attach the grounding strap.
4. Remove 4 screws, and then remove the access cover.

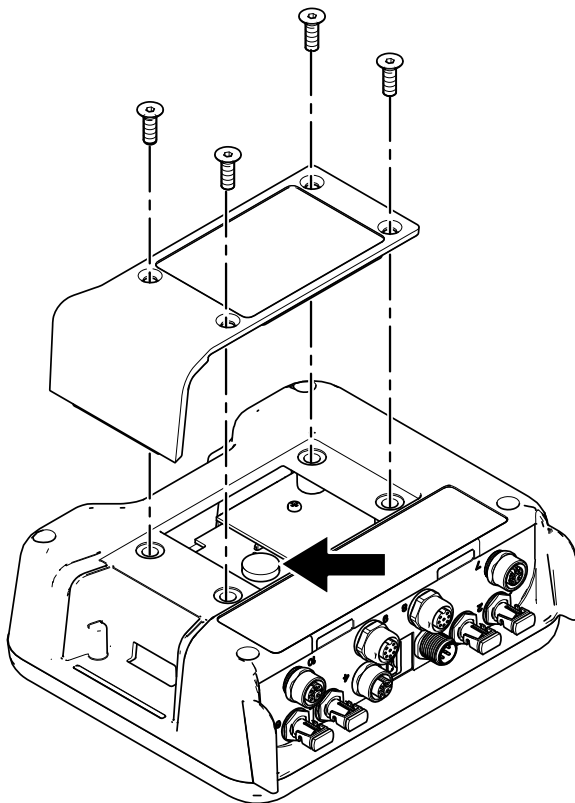

ti19096a

5. Use a flathead screwdriver to pry out the old battery.

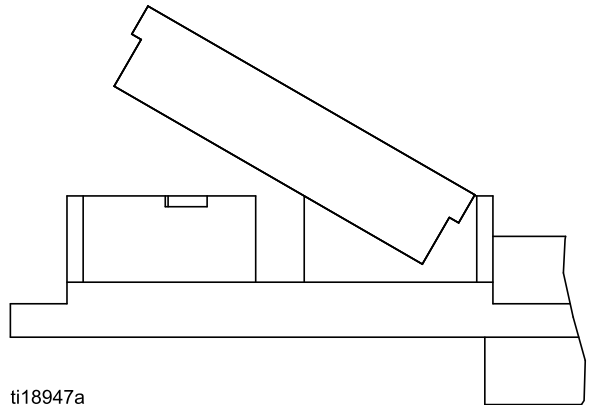

ti18947a

NOTE: Dispose of battery properly in an approved container and according to applicable local guidelines.

6. Replace with new battery. Ensure battery fits under connector tabs before snapping other end in place.

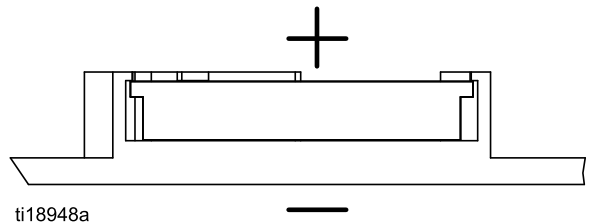

ti18948a

NOTE: Use only Panasonic CR2032 batteries for replacement.

7. Reassemble access cover and screws.
8. Snap the module back into the bracket.

Parts

ADCM Only (and with Flow Monitor) Models 25B283 and 25B284

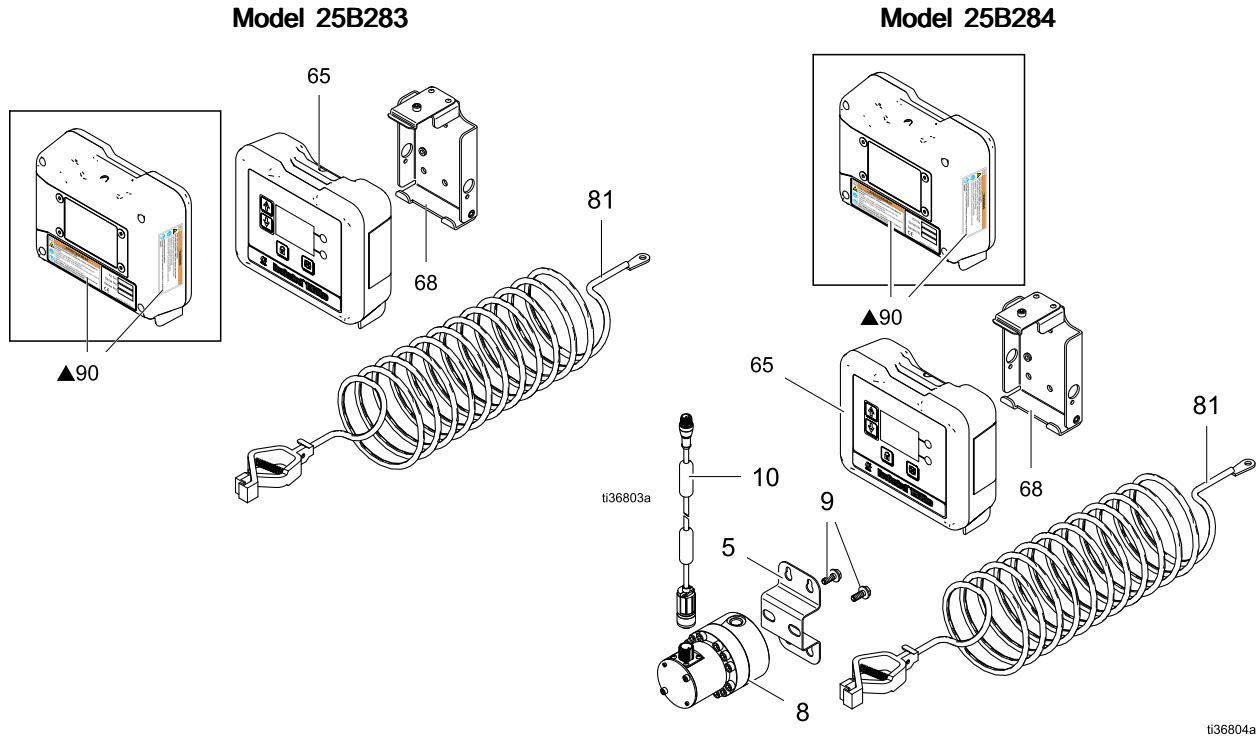
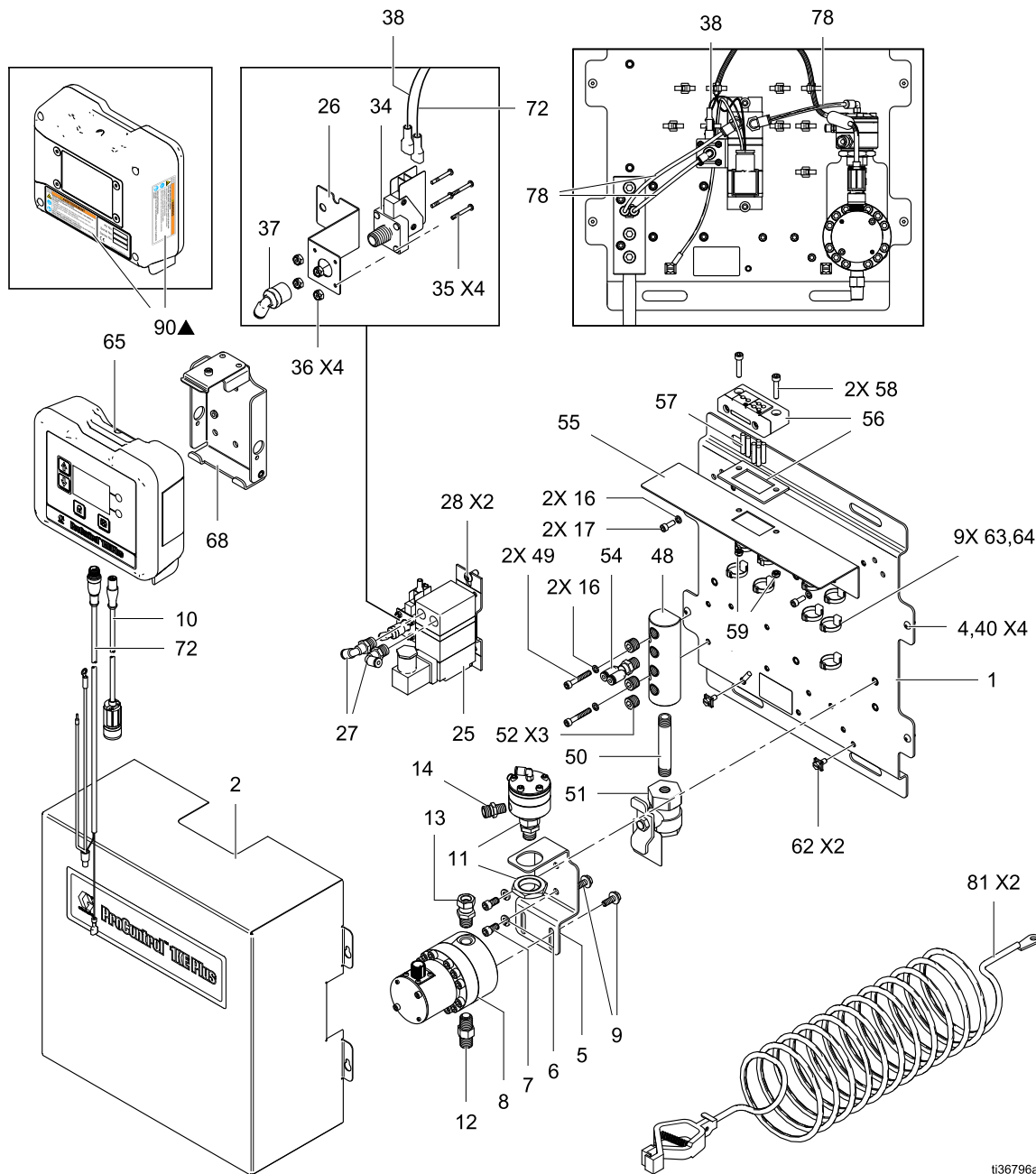

Table 15 Parts for Models 25B283 and 25B284

Ref	Part	Description	Qty	25B283	25B284
5	15U749	BRACKET, wall-mount meter	1		✓
8	289813	METER, G3000 assembly gear	1		✓
9	114182	SCREW, hex-flange machine	2		✓
10	19A908	CABLE, meter; 1.5 m	1		✓
65	—	MODULE, ADCM	1	✓	✓
68	277853	BRACKET, booth control mounting	1	✓	✓
81	244524	WIRE, ground assembly with clamp	1	✓	✓
90 [▲]	16P265	LABEL, warning safety (sheet includes labels in English, French, and Spanish)	1	✓	✓

[▲] Replacement safety labels are available at no cost.

Flow Monitor with Open Loop Pressure Setpoint Models 25B285, 25B286, 25B287, and 25B288



ti36796a

Table 16 Parts for Models 25B285, 25B286, 25B287, and 25B288

Ref	Part	Description	25B285	25B286	25B287	25B288
1	19A780	PLATE, fluid mounting	1	1	1	1
2	25B213	COVER, fluid panel	1	1	1	1
4	551787	SCREW, button head cap	4	4	4	4
5	19A781	BRACKET, inlet, fluid	1	1	1	—
6	104123	WASHER, spring lock	2	2	2	—
7	GC2248	SCREW, socket head cap; .250 x .50	2	2	2	—
8	289813	METER, G3000 assembly gear	1	1	—	—
9	114182	SCREW, hex-flange machine	2	2	—	—
10	19A908	CABLE, meter; 1.5 m	1	1	—	—
11	24C275	REGULATOR, 1:1 ratio fluid	1	—	1	—
12	501867	VALVE, check	1	1	—	—
13	114339	FITTING, swivel union; 1/4 npt	1	—	—	—
14	191929	ADAPTER	1	—	1	—
16	112906	WASHER, spring lock (not shown)	4	4	4	4
17	GC2188	SCREW, socket head cap; .190 x .500	2	2	2	2
25	16P784	TRANSDUCER, miniature I/P	1	1	1	1
26	18A989	BRACKET, pressure switch mounting	1	1	1	1
27	15T937	FITTING, swivel elbow; 1/4 npt x 5/32 t	2	2	2	2
28	112925	SCREW, button head cap	2	2	2	2
34	513937	SWITCH, pressure	1	1	1	1
35	103982	SCREW, pan head machine	4	4	4	4
36	116007	NUT, lock	4	4	4	4
37	111502	FITTING, tube	1	1	1	1
38	18B053	CABLE, I/P	1	1	1	1
40	C38163	WASHER, #10 ext. tooth lock	4	4	4	4
48	19A785	MANIFOLD, air; 1/4 npt, 4 port	1	1	1	1
49	127023	SCREW, socket head cap; 10–32	2	2	2	2
50	19A910	FITTING, nipple; 1/4 npt, 3 inch	1	1	1	1
51	116473	VALVE, vented; 2–way	1	1	1	1
52	100721	PLUG, pipe	3	3	3	3
54	18A988	FITTING, Y; 1/4 npt(m) x 5/32 tube	1	1	1	1
55	18B604	BRACKET, cable mounting	1	1	1	1
56	18B605	GLAND, multiple entry cable	1	1	1	1
57	18B606	PLUG, 5mm, cable gland	4	4	5	5
58	114380	SCREW, M5 x 25mm, socket head cap	2	2	2	2

Ref	Part	Description	25B285	25B286	25B287	25B288
59	105332	NUT, M5 lock	2	2	2	2
62	116343	SCREW, ground	2	2	2	2
63	19A945	CLIP, cable tie-down	9	9	9	9
64	103546	STRAP, wire tie	9	9	9	9
65	25B283	MODULE, ADCM (includes ref. 68, 81, and 90)	1	1	1	1
68	277853	BRACKET, booth control mounting (included with ref. 65)	1	1	1	1
72	18B393	CABLE, I/P, 2m, M12, 8 pin	1	1	1	1
78	551731	TUBE, 5/32 OD (quantity in ft.)	1.330	0.960	1.330	0.960
81	244524	WIRE, ground assembly with clamp (included with ref. 65)	2	2	2	2
90 [▲]	16P265	LABEL, warning safety (sheet includes labels in English, French, and Spanish; included with ref. 65)	1	1	1	1

[▲] Replacement safety labels are available at no cost.

Table 17 Parts for Model 25B289

Ref	Part	Description	Qty
1	19A780	PLATE, fluid mounting	1
2	25B213	COVER, fluid panel	1
4	551787	SCREW, button head cap	4
16	112906	WASHER, spring lock (not shown)	8
17	GC2188	SCREW, socket head cap; .190 x .500	2
25	16P784	TRANSDUCER, miniature I/P	1
26	18A989	BRACKET, pressure switch mounting	1
27	15T937	FITTING, swivel elbow; 1/4 npt x 5/32 t	3
28	112925	SCREW, button head cap	2
34	513937	SWITCH, pressure	1
35	103982	SCREW, pan head machine	4
36	116007	NUT, lock	4
37	111502	FITTING, tube	1
38	18B053	CABLE, I/P	1
40	C38163	WASHER, #10 ext. tooth lock	4
41	19A899	SPACER, #10; 2 inches	4
42	120435	REGULATOR, remote piloted	1
43	514930	SCREW, socket head cap	4
44	C38211	FITTING, tube	2
45	112538	FITTING, street elbow; 90°	1
46	191892	FITTING, street elbow; 90°	1
47	108190	GAUGE, air pressure	1
48	19A785	MANIFOLD, air; 1/4 npt, 4 port	1
49	127023	SCREW, socket head cap; 10-32	2
50	19A910	FITTING, nipple; 1/4 npt, 3 inch	1
51	116473	VALVE, vented; 2-way	1
52	100721	PLUG, pipe	2
53	120389	FITTING, tube	1
54	18A988	FITTING, Y; 1/4 npt(m) x 5/32 tube	1
55	18B604	BRACKET, cable mounting	1
56	18B605	GLAND, multiple entry cable	1
57	18B606	PLUG, 5mm, cable gland	5
58	114380	SCREW, M5 x 25mm, socket head cap	2
59	105332	NUT, M5 lock	2
62	116343	SCREW, ground	2

Parts

Ref	Part	Description	Qty
63	19A945	CLIP, cable tie-down	9
64	103546	STRAP, wire tie	9
65	25B283	MODULE, ADCM (includes ref. 68, 81, and 90)	1
68	277853	BRACKET, booth control mounting (included with ref. 65)	1
72	18B393	CABLE, I/P, 2m, M12, 8 pin	1
78	551731	TUBE, 5/32 OD (quantity in ft.)	1.160
79	054106	TUBE, .375 OD (quantity in ft.)	0.760
81	244524	WIRE, ground assembly with clamp (included with ref. 65)	2
90 [▲]	16P265	LABEL, warning safety (sheet includes labels in English, French, and Spanish; included with ref. 65)	1

▲ Replacement safety labels are available at no cost.

Closed Loop Fluid Pressure/Flow Control

Models 25B290, 25B291, 25B292, 25B293, 25B294, and 25B295

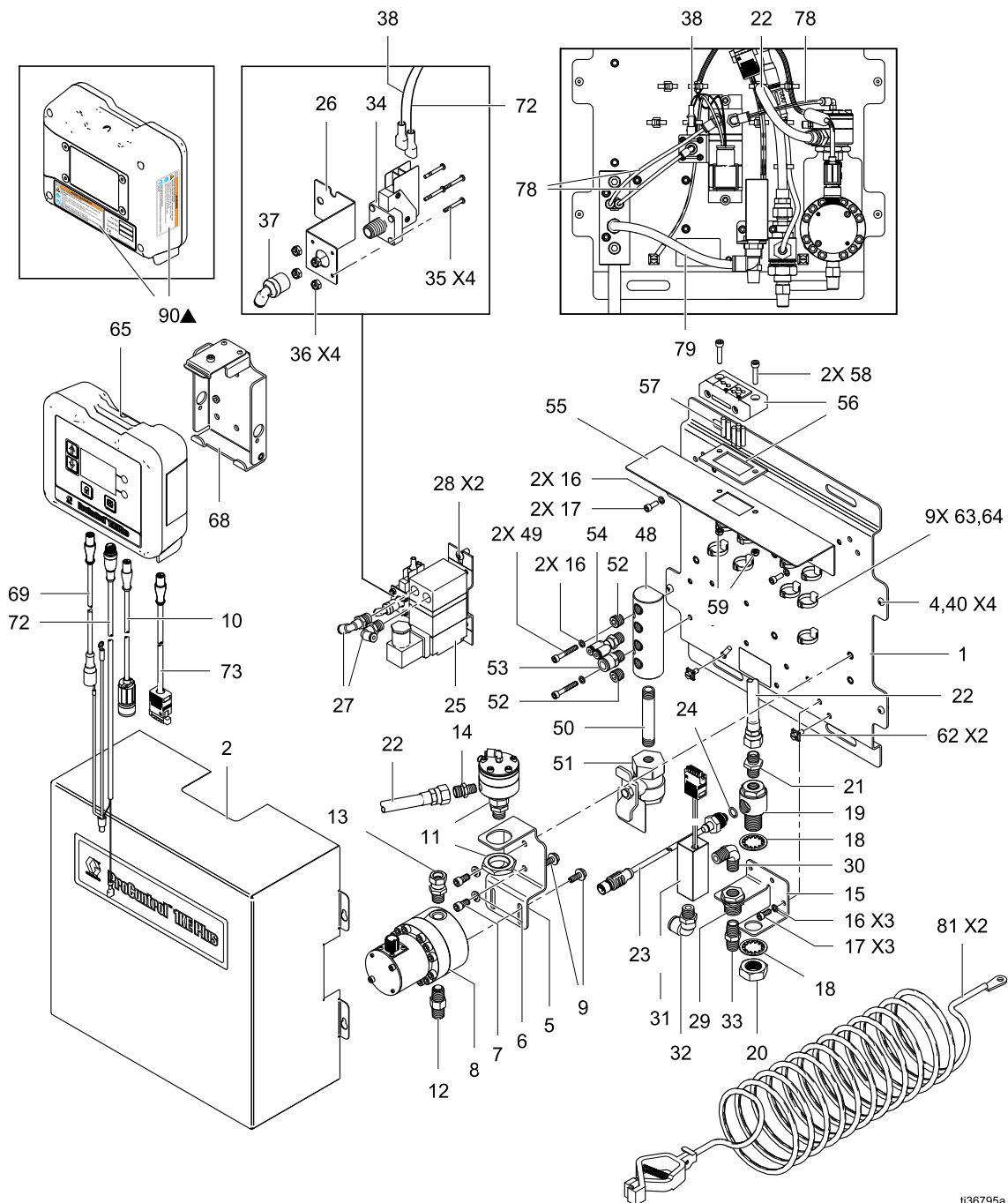

t136795a

Parts

Table 18 Parts for Models 25B290, 25B291, 25B292, 25B293, 25B294, and 25B295

Ref	Part	Description	25B290	25B291	25B292	25B293	25B294	25B295
1	19A780	PLATE, fluid mounting	1	1	1	1	1	1
2	25B213	COVER, fluid panel	1	1	1	1	1	1
4	551787	SCREW, button head cap	4	4	4	4	4	4
5	19A781	BRACKET, inlet, fluid	1	—	1	1	1	—
6	104123	WASHER, spring lock	2	—	2	2	2	—
7	GC2248	SCREW, socket head cap; .250 x .50	2	—	2	2	2	—
8	289813	METER, G3000 assembly gear	—	—	1	1	—	—
9	114182	SCREW, hex flange machine	—	—	2	2	—	—
10	19A908	CABLE, meter; 1.5 m	—	—	1	1	—	—
11	24C275	REGULATOR, 1:1 ratio fluid	1	—	1	—	1	—
12	501867	VALVE, check	—	—	1	1	—	—
13	114339	FITTING, swivel union; 1/4 npt,	—	—	1	—	—	—
14	191929	ADAPTER	1	—	1	—	1	—
15	19A782	BRACKET, air/fluid mounting	1	1	1	1	1	1
16	112906	WASHER, spring lock	7	7	7	7	7	7
17	GC2188	SCREW, socket head cap; .190 x .500	5	5	5	5	5	5
18	19A788	WASHER, internal tooth lock; 3/4 inch	2	2	2	2	2	2
19	19A783	FITTING, fluid pressure sensor	1	1	1	1	1	1
20	19A789	NUT, hex jam; stainless steel, 3/4-16	1	1	1	1	1	1
21	166846	FITTING, Adapter	1	1	1	1	1	1
22	25A721	HOSE, coupled; 1.0 ft, ptfe	1	—	1	—	1	—
23	16H282	TRANSDUCER, control pressure	1	1	1	1	1	1
24	111316	PACKING, o-ring	1	1	1	1	1	1

Ref	Part	Description	25B290	25B291	25B292	25B293	25B294	25B295
25	16P784	TRANSDUCER, miniature I/P	1	1	1	1	1	1
26	18A989	BRACKET, pressure switch mounting	1	1	1	1	1	1
27	15T937	FITTING, swivel elbow; 1/4 npt x 5/32 t	2	2	2	2	2	2
28	112925	SCREW, button head cap	2	2	2	2	2	2
29	101641	FITTING, bulkhead	1	1	1	1	1	1
30	111763	FITTING, elbow; 1/4 npt	1	1	1	1	1	1
31	18B571	KIT, AFS	1	1	1	1	1	1
32	121141	FITTING, swivel elbow; 3/8 t, 1/4 npt(m)	1	1	1	1	1	1
33	113029	NIPPLE, 1/4 x 1/4 npt	1	1	1	1	1	1
34	513937	SWITCH, pressure	1	1	1	1	1	1
35	103982	SCREW, pan head machine	4	4	4	4	4	4
36	116007	NUT, lock	4	4	4	4	4	4
37	111502	FITTING, tube	1	1	1	1	1	1
38	18B053	CABLE, I/P	1	1	1	1	1	1
40	C38163	WASHER, #10 ext. tooth lock	4	4	4	4	4	4
48	19A785	MANIFOLD, air; 1/4 npt, 4 port	1	1	1	1	1	1
49	127023	SCREW, socket head cap; 10-32	2	2	2	2	2	2
50	19A910	FITTING, nipple; 1/4 npt, 3 inch	1	1	1	1	1	1
51	116473	VALVE, vented; 2-way	1	1	1	1	1	1
52	100721	PLUG, pipe	2	2	2	2	2	2
53	120389	FITTING, tube	1	1	1	1	1	1
54	18A988	FITTING, Y; 1/4 npt(m) x 5/32 tube	1	1	1	1	1	1
55	18B604	BRACKET, cable mounting	1	1	1	1	1	1
56	18B605	GLAND, multiple entry cable	1	1	1	1	1	1

Parts

Ref	Part	Description	25B290	25B291	25B292	25B293	25B294	25B295
57	18B606	PLUG, 5mm, cable gland	3	3	2	2	3	3
58	114380	SCREW, M5 x 25mm, socket head cap	2	2	2	2	2	2
59	105332	NUT, M5 lock	2	2	2	2	2	2
62	116343	SCREW, ground	2	2	2	2	2	2
63	19A945	CLIP, cable tie-down	9	9	9	9	9	9
64	103546	STRAP, wire tie	9	9	9	9	9	9
65	25B283	MODULE, ADCM (includes ref. 68, 81, and 90)	1	1	1	1	1	1
68	277853	BRACKET, booth control mounting (included with ref. 65)	1	1	1	1	1	1
69	19A906	CABLE, M12, reverse key, non-IS	1	1	1	1	1	1
72	18B393	CABLE, I/P, 2m, M12, 8 pin	1	1	1	1	1	1
73	18B570	CABLE, ADCM to AFS	1	1	1	1	1	1
78	551731	TUBE, 5/32 OD (quantity in ft.)	1.330	0.960	1.330	0.960	1.330	0.960
79	054106	TUBE, .375 OD (quantity in ft.)	0.620	0.620	0.620	0.620	0.620	0.620
81	244524	WIRE, ground assembly with clamp (included with ref. 65)	2	2	2	2	2	2
90▲	16P265	LABEL, warning safety (sheet includes labels in English, French, and Spanish; included with ref. 65)	1	1	1	1	1	1

▲ Replacement safety labels are available at no cost.

Closed Loop Fluid Pressure/Flow and Gun Atomizing Air Control Models 25B296, 25B297, 25B298, and 25B299

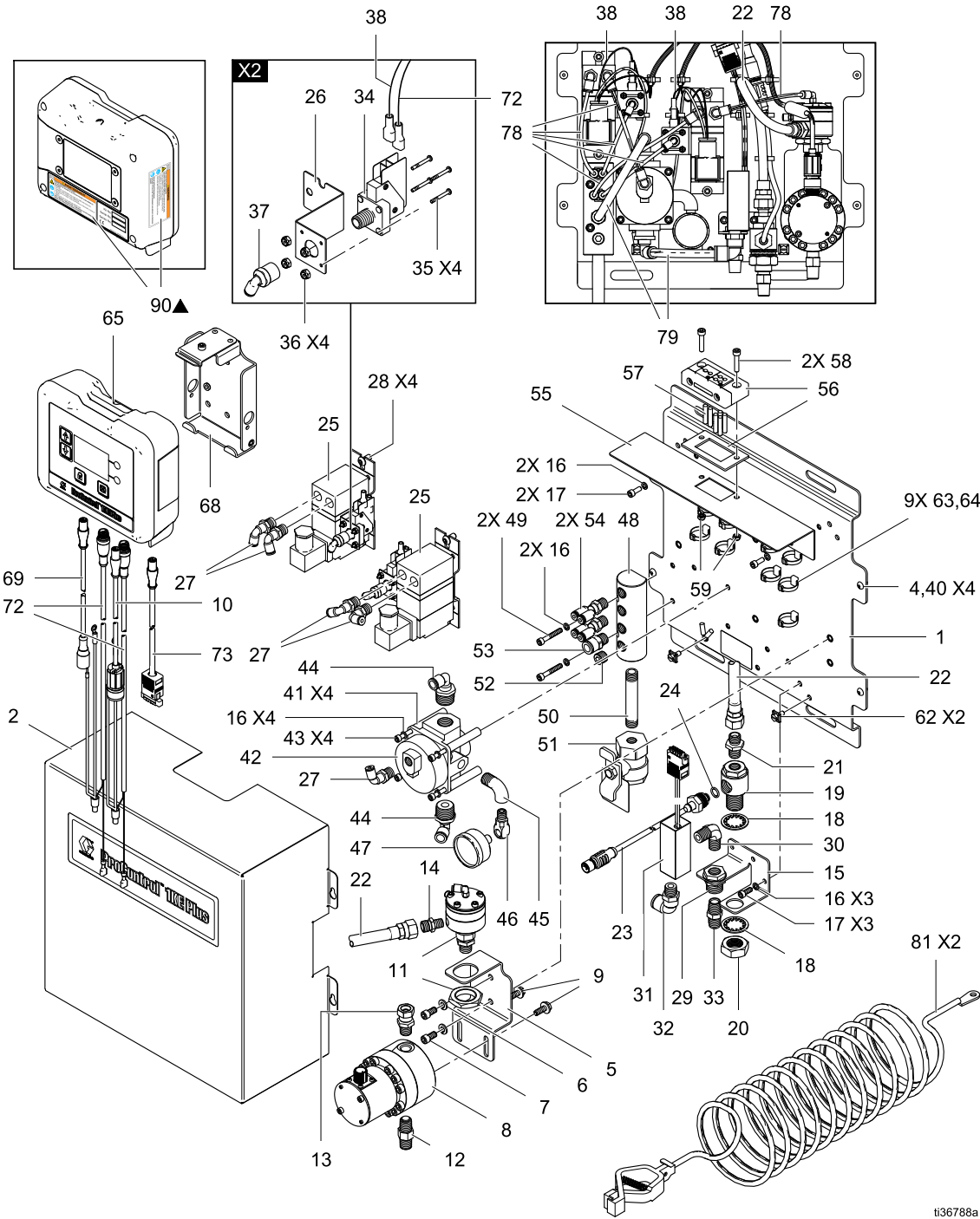

t136788a

Parts

Table 19 Parts for Models 25B296, 25B297, 25B298, and 25B299

Ref	Part	Description	25B296	25B297	25B298	25B299
1	19A780	PLATE, fluid mounting	1	1	1	1
2	25B213	COVER, fluid panel	1	1	1	1
4	551787	SCREW, button head cap	4	4	4	4
5	19A781	BRACKET, inlet, fluid	1	1	1	—
6	104123	WASHER, spring lock	2	2	2	—
7	GC2248	SCREW, socket head cap; .250 x .50	2	2	2	—
8	289813	METER, G3000 assembly gear	1	1	—	—
9	114182	SCREW, hex-flange machine	2	2	—	—
10	19A908	CABLE, meter; 1.5 m	1	1	—	—
11	24C275	REGULATOR, 1:1 ratio fluid	1	—	1	—
12	501867	VALVE, check	1	1	—	—
13	114339	FITTING, swivel union; 1/4 npt,	1	—	—	—
14	191929	ADAPTER	1	—	1	—
15	19A782	BRACKET, air/fluid mounting	1	1	1	1
16	112906	WASHER, spring lock	11	11	11	11
17	GC2188	SCREW, socket head cap; .190 x .500	5	5	5	5
18	19A788	WASHER, internal tooth lock; 3/4 inch	2	2	2	2
19	19A783	FITTING, fluid pressure sensor	1	1	1	1
20	19A789	NUT, hex jam; stainless steel, 3/4–16	1	1	1	1
21	166846	FITTING, Adapter	1	1	1	1
22	25A721	HOSE, coupled; 1.0 ft, ptfе	1	—	1	—
23	16H282	TRANSDUCER, control pressure	1	1	1	1
24	111316	PACKING, o-ring	1	1	1	1
25	16P784	TRANSDUCER, miniature I/P	2	2	2	2
26	18A989	BRACKET, pressure switch mounting	2	2	2	2
27	15T937	FITTING, swivel elbow; 1/4 npt x 5/32 t	5	3	5	5
28	112925	SCREW, button head cap	4	4	4	4
29	101641	FITTING, bulkhead	1	1	1	1
30	111763	FITTING, elbow; 1/4 npt	1	1	1	1
31	18B571	KIT, AFS	1	1	1	1
32	121141	FITTING, swivel elbow; 3/8 t, 1/4 npt(m)	1	1	1	1
33	113029	NIPPLE, 1/4 x 1/4 npt	1	1	1	1
34	513937	SWITCH, pressure	2	2	2	2
35	103982	SCREW, pan head machine	8	8	8	8
36	116007	NUT, lock	8	8	8	8



Ref	Part	Description	25B296	25B297	25B298	25B299
37	111502	FITTING, tube	2	2	2	2
38	18B053	CABLE, I/P	2	2	2	2
40	C38163	WASHER, #10 ext. tooth lock	4	4	4	4
41	19A899	SPACER, #10; 2 inches	4	4	4	4
42	120435	REGULATOR, remote piloted	1	1	1	1
43	514930	SCREW, socket head cap	4	4	4	4
44	C38211	FITTING, tube	2	2	2	2
45	112538	FITTING, street elbow; 90°	1	1	1	1
46	191892	FITTING, street elbow; 90°	1	1	1	1
47	108190	GAUGE, air pressure	1	1	1	1
48	19A785	MANIFOLD, air; 1/4 npt, 4 port	1	1	1	1
49	127023	SCREW, socket head cap; 10-32	2	2	2	2
50	19A910	FITTING, nipple; 1/4 npt, 3 inch	1	1	1	1
51	116473	VALVE, vented; 2-way	1	1	1	1
52	100721	PLUG, pipe	1	1	1	1
53	120389	FITTING, tube	1	1	1	1
54	18A988	FITTING, Y; 1/4 npt(m) x 5/32 tube	2	2	2	2
55	18B604	BRACKET, cable mounting	1	1	1	1
56	18B605	GLAND, multiple entry cable	1	1	1	1
57	18B606	PLUG, 5mm, cable gland	1	1	2	2
58	114380	SCREW, M5 x 25mm, socket head cap	2	2	2	2
59	105332	NUT, M5 lock	2	2	2	2
62	116343	SCREW, ground	2	2	2	2
63	19A945	CLIP, cable tie-down	9	9	9	9
64	103546	STRAP, wire tie	9	9	9	9
65	25B283	MODULE, ADCM (includes ref. 68, 81, and 90)	1	1	1	1
68	277853	BRACKET, booth control mounting (included with ref. 65)	1	1	1	1
69	19A906	CABLE, M12, reverse key, non-IS	1	1	1	1
72	18B393	CABLE, I/P, 2m, M12, 8 pin	2	2	2	2
73	18B570	CABLE, ADCM to AFS	1	1	1	1
78	551731	TUBE, 5/32 OD (quantity in ft.)	2.490	2.120	2.490	2.120
79	054106	TUBE, .375 OD (quantity in ft.)	1.110	1.110	1.110	1.110
81	244524	WIRE, ground assembly with clamp (included with ref. 65)	2	2	2	2

Parts

Ref	Part	Description	25B296	25B297	25B298	25B299
90 [▲]	16P265	LABEL, warning safety (sheet includes labels in English, French, and Spanish; included with ref. 65)	1	1	1	1

▲ Replacement safety labels are available at no cost.

Accessories

				
<p>Not all accessories and kits are approved for use in hazardous locations. To avoid serious injury or death from fire and explosion and electrical shock, refer to the specific accessory and kit manuals for approval details.</p>				

Power

Part No.	Description
16V680	Non-Intrinsically Safe (Non-IS) Power Supply, 100-240 VAC input, 50/60 Hz, 15 VDC output
16M167	Intrinsically Safe (IS) Power Supply Module, 100-240 VAC input. Includes 50 ft (15 m) IS power cable
26C724	G-Barrier Intrinsically Safe (IS) Power Module, provides up to three IS power output circuits. 100-240 VAC, 50/60 Hz, input. Includes one IS 50 ft (15 m) IS power cable

Cables

Non-Intrinsically Safe Cables

Part No.	Description
18A987	Meter Cable Extension, 50 ft (15 m), for meter cable, port #4
16V069	Non-IS Power Cable, 50 ft (15 m)
16V070	Non-IS Power Cable, 100 ft (30 m)
16V380	Non-IS Sensor Cable, 50' (15 m), ports #7 and #10
16P791	Non-IS Control Cable, 50' (15 m), ports #8 and #9
18A986	Indicator Light Cable, 50' (15 m), fluid panel to light

Intrinsically Safe Cables

Part No.	Description
19Y499	IS Power Cable, 50 ft (15 m), for power supply
19Y502	IS Power Cable, 100 ft (30 m), for power supply
18B244	IS Meter Cable Extension, 50 ft (15 m), meter cable, port #4
16V381	IS Sensor Cable, 50' (15 m), ports #7 and #10
16V071	IS Control Cable, 50' (15 m), ports #8 and #9

Fiber Optic Communication Cable

Part No.	Description
17T898	10 ft (3 m) Fiber Optic Cable
16M172	50 ft (15 m) Fiber Optic Cable
16M173	100 ft (30 m) Fiber Optic Cable

Hardware Upgrades

Part No.	Description
25B322	Basic Upgrade Kit includes basic fluid plate and hardware to allow custom configuration by end user or update of previous generation ProControl 1KE system to new 1KE Plus platform.
25B323	Air Control Upgrade Kit adds air control to a ProControl 1KE Plus fluid plate.
25B325	Pressure Switch Conversion Kit converts ProControl 1KE Plus fluid plate gun air flow switch to a pressure switch for detection of gun on conditions.

Software Upgrades

Part No.	Description
25B324	ProControl 1KE Plus Software Token Kit with instruction manual 3A1244.

Indicators

Part No.	Description
25P594	IS Indicator Light Tower, 2 color light with bracket and cables

Supply Air

Part No.	Description
570122	Dual Unit Air Filter and Regulator Assembly with 5 µm filter, manual drain, and mounting bracket

Interfaces

Part No.	Description
24R086	Fiber Optic to Serial Converter module with 24V, 2 amp power supply and enclosure, communicates from ProControl 1KE Plus to a PLC. See manual 332356 for details.
24N978	Fiber Optic to Serial Converter, communicates from the ProControl 1KE Plus to a PLC. See manual 332356 for details.

Meters and Transducers

Part No.	Description
289813	G3000 Meter — Positive displacement, gear flow meter, 0.02 to 1.0 gpm (75 to 3800 cc/min), for low to medium viscosity materials
280560	HG6000 Meter — Positive displacement, helical gear flow meter, 0.013 to 6.0 gpm (50 to 22,712 cc/min), for high flow, high viscosity materials
258718	S3000 Solvent Meter — Positive displacement, gear flow meter, 0.01 to 0.5 gpm (38 to 1900 cc/min), for light viscosity materials
25P592	Pressure Transducer Kit, 100 psi (7 bar, 0.7 MPa) Used to measure fluid pressure
25P593	High Pressure Sensor Kit, 4500 psi (310 bar, 31.0 MPa) Used to convert to higher pressure operation
25B359	Medium Pressure Sensor Kit, 2000 psi (138 bar, 13.8 MPa) Used to convert to higher pressure operation

Coriolis Meter Kit

Non-intrusive mass flow meter, for abrasive and filled materials and a range of flow rates.

Part No.	Description
24N525	1/4 in. Coriolis Flow Meter Kit

Fluid Regulators

Part No.	Description
24C375	1:1 Low Flow Regulator
24E471	1:2 Low Flow Regulator
24E472	1:3 Low Flow Regulator
234266	High Flow Regulator

Electrical Schematic

ProControl 1KE Plus

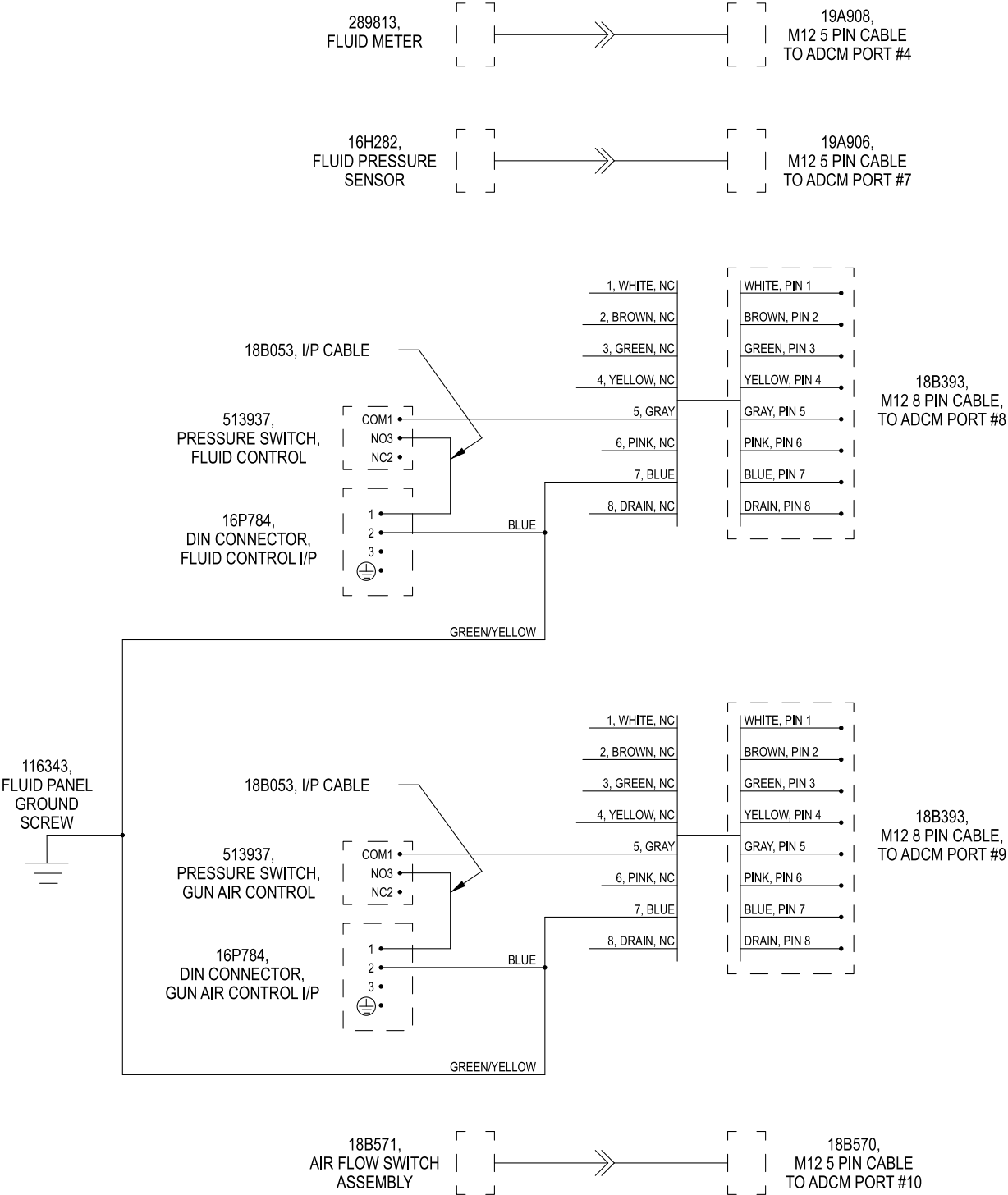

Mounting Dimensions

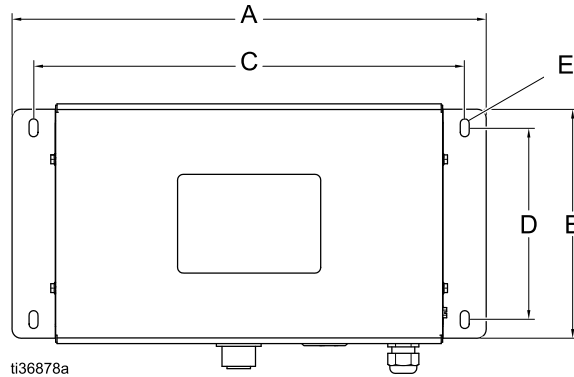

Power Supply 16M167 and 26C724

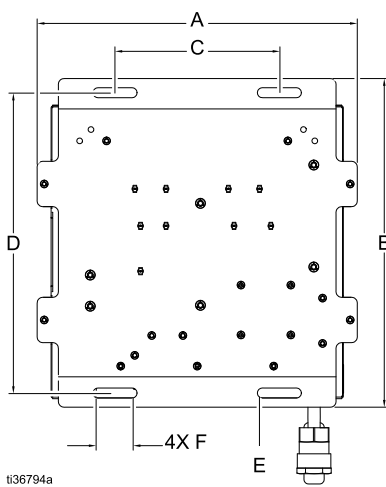

Fluid and Air Controls Mounting Panel

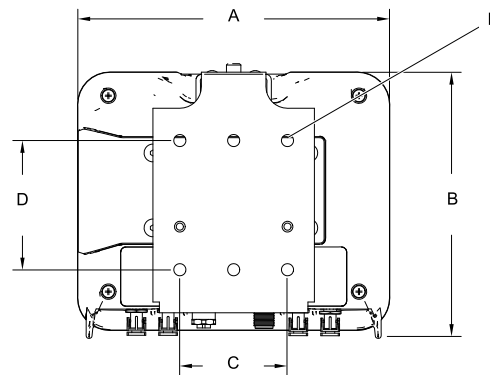

ProControl 1KE Plus ADCM

Component	A Overall Width in. (mm)	B Overall Height in. (mm)	Overall Depth in. (mm)	Mounting Dimensions Width (C) x Height (D) in. (mm)	E Mounting Hole Size in. (mm)	F Slot Length in. (mm)
Fluid and Air Controls Mounting Panel	9.5 (241.3)	9.0 (228.6)	0.5 (12.7)	8.5 x adjustable from 5.0–8.0 (212.5 x 127.0–203.2)	0.5 (12.7)	1.5 (38.1)
Power Supply 16M167	16.6 (420.9)	8.7 (221.2)	4.5 (114.8)	15.1 x 6.7 (382.8 x 170.2)	0.31 (7.9)	n/a
ProControl 1KE Plus ADCM	7.2 (183)	6.0 (152)	2.8 (71)	2.5 x 3.0 (64 x 76)	0.28 (7.0)	n/a

Appendix A - Modbus Variable Map

Device Identification Registers

Address	Description	Permissions	Size	Units
401040	Software Version Major	Read Only	32 Bit	String, 4 Bytes
401042	Software Version Minor	Read Only	32 Bit	String, 4 Bytes
401044	Software Version Build	Read Only	32 Bit	String, 4 Bytes
401072	Serial Number String - Bytes 0-3	Read Only	32 Bit	String, 4 Bytes
401074	Serial Number String - Bytes 4-7	Read Only	32 Bit	String, 4 Bytes
401076	Serial Number String - Bytes 8-11	Read Only	32 Bit	String, 4 Bytes
401078	Serial Number String - Bytes 12-15	Read Only	32 Bit	String, 4 Bytes
401080	Serial Number String - Bytes 16-19	Read Only	32 Bit	String, 4 Bytes
401082	Serial Number String - Bytes 20-23	Read Only	32 Bit	String, 4 Bytes
401084	Serial Number String - Bytes 24-27	Read Only	32 Bit	String, 4 Bytes
401086	Serial Number String - Bytes 28-31	Read Only	32 Bit	String, 4 Bytes

Run Registers

All registers are 32-bit.

Address	Description	Permissions	Units	Low	High	Notes
402000	Date, Year	Read/Write	YY	1	99	Limited to 2099
402002	Date, Month	Read/Write	MM	1	12	
402004	Date, Day	Read/Write	DD	1	31	
402006	Time, Hour	Read/Write	HH	0	23	
402008	Time, Minute	Read/Write	MM	0	59	
402010	Time, Second	Read/Write	SS	0	59	
402012	Alarms Needing Acknowledgment	Read/Write	Bitfield	0	32-bit	See Alarm Bitfield Table, page 83
402014	Current Grand Total	Read	cc	0	32-bit	
402016	Current Batch Total	Read/Write	cc	0	999999	Write 0 to reset
402018	Current Maintenance Total	Read/Write	cc	0	9999999	Write 0 to reset
402020	Current Flow Rate	Read	cc/min	0	65535	
402022	Current Pressure	Read	bar	0	32-bit	Scaled as 1 bar = 65536
402024	Unused					
402026	Calibration Mode	Read/Write	Bit	0	1	0 = Off 1 = On
402028	Calibration, Measured Volume	Read/Write	cc	0	32-bit	
402030	Calibration, Actual Dispensed Volume	Read/Write	cc	0	32-bit	
402032	Dispense Mode	Read/Write	Selection	0	3	0 = Standby 1 = Flush 2 = Fill 3 = Dispense
402034	Gun Trigger On Time	Read	ms	0	32-bit	
402036	Current Job Spray Total	Read	cc	0	24-bit	
402038	Current Job Flush Total	Read	cc	0	24-bit	
402040	Current Job Number	Read/Write	Value	0	32-bit	Automatically increments
402042	Job Attribute	Read/Write	Value	0	32-bit	Use for identification of the user, station, part, etc.
402044	Job Gun Trigger Time	Read	ms	0	32-bit	
402046	Unused					
402048	Unused					

Alarm Bitfield Table

Clear an individual alarm by writing the value to the Modbus register 402012 (see [Run Registers, page 82](#)).

Code	Summary	Hex
Any	All alarms are cleared	0x0000
F3	High Flow	0x0001
F2	Low Flow	0x0002
MF	Maintenance Counter	0x0004
P3	High Pressure	0x0008
P2	Low Pressure	0x0010
F6	Runaway Flow	0x0020
P6	Runaway Pressure	0x0040
SN	Minimum Fill Volume	0x0080
SP	Minimum Flush Volume	0x0100
EU	System Idle	0x0200

Code	Summary	Hex
QT	Dose Time	0x0400
B4	Job Dispense High	0x0800
B1	Job Dispense Low	0x1000
G2	Gun Off Setpoint	0x2000

All alarms may be cleared by writing 0x0 to the register. If alarms are to be cleared individually, write the bitmask of the alarms to be cleared. If the PLC write cycle does not allow writing the same value to the register, one of the presently unused bits, such as 0x80000000 or 0x40000000, may be added to the bitmask to allow the write cycle.

Run Setpoint Registers

All registers are 32-bit.

Address	Description	Permissions	Units	Low	High	Notes
402050	Fluid setpoint as percentage of 4 to 20 mA range	Read/Write	Percent	0	99.9	Scaled as 1% = 65536 Active when 403094 = 0 (See Setup Registers, page 84)
402052	Fluid setpoint as drive current	Read/Write	uA	0	32000	1 mA = 1000 Active when 403094 = 3 (See Setup Registers, page 84)
402054	Fluid setpoint as pressure	Read/Write	bar	0	32-bit	Scaled as 1 bar = 65536 Active when 403094 = 1 (See Setup Registers, page 84)
402056	Fluid setpoint as flow rate	Read/Write	cc/min	0	65535	Activ when 403094 = 2 (See Setup Registers, page 84)
402058	Readback current	Read	uA	0	32000	1 mA = 1000
402060	Atomizing air setpoint as percentage of 4 to 20 mA range	Read/Write	Percent	0	99.9	Scaled as 1% = 65536 Active when 403094 = 0 (See Setup Registers, page 84)
402062	Unused					
402064	Unused					
402066	Unused					
402068	Unused					

Setup Registers

All registers are 32-bit.

Address	Description	Permissions	Units	Low	High	Notes
403000	Communication, Modbus Mode	Read/Write	Bit	0	1	0 = Off 1 = On
403002	Communication, Modbus Address	Read/Write	Value	1	247	
403004	Communication, Modbus Baud Rate	Read/Write	Value	0	4	0 = 9600 1 = 19200 2 = 38400 3 = 578600 4 = 115200
403006	Communication, Modbus Parity	Read/Write	Value	0	2	0 = None 1 = Odd 2 = Even
403008	Communication, Modbus Stop Bits	Read/Write	Value	1	2	
403010	Display, Date Format	Read/Write	Value	0	2	0 = MM/DD/YY 1 = DD/MM/YY 2 = YY/MM/DD
403012	Display, Backlight Timer	Read/Write	minutes	0	99	0 = Always On
403014	Display, Maintenance Totalizer Alarm Enable	Read/Write	Bit	0	1	0 = Off 1 = On
403016	Display, Flow Rate Alarm Enable	Read/Write	Bit	0	1	0 = Off 1 = On Used for F3 and F2 alarms
403018	Display, Flow Rate Alarm Auto Clear	Read/Write	Bit	0	1	0 = Off 1 = On Used for F3 and F2 deviations
403020	Unused					
403022	Pressure Transducer Enable	Read/Write	Bit	0	1	0 = Off 1 = On
403024	Units, Flow Rate	Read/Write	Value	0	2	0 = cc/min 1 = l/min 2 = gal/min
403026	Units, Pressure	Read/Write	Value	0	2	0 = psi 1 = bar 2 = MPa
403028	Units, Batch Volume	Read/Write	Value	0	2	0 = cc 1 = l 2 = gal
403030	Units, Grand Volume	Read/Write	Value	0	2	0 = cc 1 = l 2 = gal
403032	System, Maintenance Target	Read/Write	cc	0	9999999	Used for MF advisory
403034	Percentage Drive Maximum Setpoint	Read/Write	Percent	0	99.9	Scaled as 1% = 65536 Active when 403094 = 0

Appendix A - Modbus Variable Map

Address	Description	Permissions	Units	Low	High	Notes
403036	Percentage Drive Minimum Setpoint	Read/Write	Percent	0	99.0	Scaled as 1% = 65536 Active when 403094 = 0
403038	System, Flow Rate Maximum	Read/Write	cc	0	999000	Used for F3 alarm
403040	System, Flow Rate Minimum	Read/Write	cc	0	999000	Used for F2 alarm
403042	System, Meter K-Factor	Read/Write	cc/pulse	0x028F	0x3E7FFFF	1 cc = 65536
403044	System, Pressure Transducer Type	Read/Write	Value	0	3	0 = Not Installed 1 = 16H282 100 psi 2 = 16P289 500 psi 3 = 15M669 7500 psi
403046	System, Pressure Transducer Offset	Read/Write	mV			
403048	System, Pressure Transducer Scale	Read/Write	mV/bar			
403050	System, Job Volume Units	Read/Write	Value	0	2	0 = cc 1 = l 2 = gal
403052	System, Pressure Maximum	Read/Write	bar	0	0x44E584	Scaled as 1 bar = 65536 Used for P3 alarm
403054	System, Pressure Minimum	Read/Write	bar	0	0x44E584	Scaled as 1 bar = 65536 Used for P2 alarm
403056	Display, Pressure Alarm Enable	Read/Write	bar	0	1	0 = Off 1 = On Used for P3 and P2 alarms
403058	Software version identifier	Read/Write	Value	0	32-bit	
403060	Password	Read/Write	Value	0	9999	
403062	Flow alarm range as percentage of setpoint	Read/Write	Bit	0	1	
403064	Flow alarm range percentage of setpoint	Read/Write	Value	0	99	
403066	Pressure alarm range as percentage of setpoint	Read/Write	Bit	0	1	
403068	Pressure alarm range percentage of setpoint	Read/Write	Value	0	99	
403070	Unused	Read/Write				
403072	Logged job maximum target	Read/Write	cc	0	999999	
403074	Logged job minimum target	Read/Write	cc	0	999999	
403076	Logged job target alarm enable	Read/Write	Bit	0	1	
403078	Display, Pressure Alarm Auto Clear	Read/Write	Bit	0	1	0 = Off 1 = On Used for P3 and P2 deviations

Appendix A - Modbus Variable Map

Address	Description	Permissions	Units	Low	High	Notes
403080	Pressure PID Kp	Read/Write	Value	0	999	
403082	Pressure PID Ki	Read/Write	Value	0	999	
403084	Pressure PID Kd	Read/Write	Value	0	999	
403086	Fill mode fluid drive percentage	Read/Write	Value	0	100	
403088	Fill mode drive timeout	Read/Write	Value	0	500	
403090	Flush mode fluid drive percentage	Read/Write	Value	0	100	
403092	Flush mode drive timeout	Read/Write	Value	0	500	
403094	Operational Mode	Read/Write	Value	0	3	0 = Monitor 1 = Pressure Control 2 = Flow Control 3 = Current
403096	Pressure maximum setpoint limit	Read/Write	bar	0	0x63E667	Scaled as 1 bar = 65536
403098	Pressure minimum setpoint limit	Read/Write	bar	0	0x63E667	Scaled as 1 bar = 65536
403100	Pressure Control internal setpoint	Read/Write	bar	0	0x63E667	Scaled as 1 bar = 65536
403102	Unused	Read/Write				
403104	Unused	Read/Write				
403106	Flow PID Kp	Read/Write	Value	0	999	
403108	Flow PID Ki	Read/Write	Value	0	999	
403110	Flow PID Kd	Read/Write	Value	0	999	
403112	Flow Control internal setpoint	Read/Write	cc/min	0	32-bit	
403114	Unused	Read/Write				
403116	Unused	Read/Write				
403118	Unused	Read/Write				
403120	Unused	Read/Write				
403122	Unused	Read/Write				
403124	Unused	Read/Write				
403126	Unused	Read/Write				
403128	Unused	Read/Write				
403130	Unused	Read/Write				
403132	Unused	Read/Write				
403134	Unused	Read/Write				
403136	Unused	Read/Write				
403138	Unused	Read/Write				
403140	Unused	Read/Write				
403142	Unused	Read/Write				
403144	Unused	Read/Write				
403146	Unused	Read/Write				
403148	Unused	Read/Write				

Appendix A - Modbus Variable Map

Address	Description	Permissions	Units	Low	High	Notes
403150	Unused	Read/Write				
403152	Flow Rate maximum setpoint limit	Read/Write	cc/min	0	9999	
403154	Flow Rate minimum setpoint limit	Read/Write	cc/min	0	9999	
403156	Atomizing Air percentage drive maximum	Read/Write	Percent	0	0x63E667	Scaled as 1 % = 65536
403158	Atomizing Air percentage drive minimum	Read/Write	Percent	0	0x63E667	Scaled as 1 % = 65536
403160	Flow Control PID gain percentage	Read/Write	Percent	1	100	
403162	System Idle timeout	Read/Write	minutes	0	99	0 = Not used
403164	Dose Time timeout	Read/Write	seconds	0	99	0 = Not used
403166	Job Attribute code	Read/Write	Value	0	32-bit	
403168	Job trigger time	Read/Write	ms	0	32-bit	
403170	Unused					
403172	Unused					

Technical Specifications

ProControl 1KE Plus	US	Metric
Maximum Pressures		
Maximum inlet air pressure	100 psi	0.7 MPa, 6.9 bar
Maximum fluid working pressure – See ProControl 1KE Plus Pressure Ratings, page 4 , for specific model configurations		
Components		
289813 G3000 Meter	4000 psi	27.6 MPa, 275.8 bar
24C375 Fluid Regulator, Air inlet pressure	100 psi	0.7 MPa, 6.9 bar
24C375 Fluid Regulator, Fluid inlet pressure	300 psi	2.1 MPa, 20.7 bar
Fluid panel fluid fittings	4600 psi	31.7 MPa, 317.2 bar
Fluid regulator outlet hose, 25A721	3000 psi	20.7 MPa, 206.8 bar
Atomizing air regulator, 120435	300 psi	2.1 MPa, 20.7 bar
Power Input Requirements for 16V680 Power Supply for Non-Hazardous Locations		
Voltage	100 – 240 VAC	
Frequency	50 – 60 Hz	
Phase	1	
Amps	1.2 A maximum	
Power Input Requirements for 16M167 or 26C724 Power Supplies for Hazardous Locations		
See manual 332196 for power supply characteristics, requirements, and installation information.		
Power Output Ratings		
Power Supply Module 16V680	15 VDC, 1.2 A maximum	
Power Supply Module 16M167	15 VDC, 160 mA maximum	
Power Supply Module (w/G-Barrier) 24C724	24 VAC, 160 mA maximum	
Air Consumption		
I/P Transducer (use only clean, dry, oil-free air, filtered through at least a 40 micron filter)	4.5 scfh (ea.) typical	
Air Regulator, 120435	0 – 195 scfm	
Environmental		
Operating Temperature	32° - 122°F	0° - 50°C
Storage Temperature	-22° - 140°F	-30° - 60°C
Humidity	0 to 95 percent, non-condensing	
Display housing is solvent resistant.		
Sound Data		
All Modules		
Sound power	< 75 dB	

Wetted Parts		
Meter	See G3000 meter manual (308778) or Coriolis meter manual (313599)	
Fluid Regulator	See Fluid Regulator Manual (3A0427)	
Fittings	17-4, 17-7, 303, 304, 316 Stainless Steel, PTFE	
Weight		
ProControl 1KE Plus ADCM	1.5 lb	0.68 kg
Mounting Bracket	1 lb	0.45 kg
Power Supply 16V680	1.5 lb	0.68 kg
Power Supply 16M167	9 lb	4.1 kg
Power Supply 26C724	9.5 lb	4.3 kg
Fluid Panel (fully populated)	27.4 lb	12.45 kg

Graco Standard Warranty

Graco warrants all equipment referenced in this document which is manufactured by Graco and bearing its name to be free from defects in material and workmanship on the date of sale to the original purchaser for use. With the exception of any special, extended, or limited warranty published by Graco, Graco will, for a period of twelve months from the date of sale, repair or replace any part of the equipment determined by Graco to be defective. This warranty applies only when the equipment is installed, operated and maintained in accordance with Graco's written recommendations.

This warranty does not cover, and Graco shall not be liable for general wear and tear, or any malfunction, damage or wear caused by faulty installation, misapplication, abrasion, corrosion, inadequate or improper maintenance, negligence, accident, tampering, or substitution of non-Graco component parts. Nor shall Graco be liable for malfunction, damage or wear caused by the incompatibility of Graco equipment with structures, accessories, equipment or materials not supplied by Graco, or the improper design, manufacture, installation, operation or maintenance of structures, accessories, equipment or materials not supplied by Graco.

This warranty is conditioned upon the prepaid return of the equipment claimed to be defective to an authorized Graco distributor for verification of the claimed defect. If the claimed defect is verified, Graco will repair or replace free of charge any defective parts. The equipment will be returned to the original purchaser transportation prepaid. If inspection of the equipment does not disclose any defect in material or workmanship, repairs will be made at a reasonable charge, which charges may include the costs of parts, labor, and transportation.

THIS WARRANTY IS EXCLUSIVE, AND IS IN LIEU OF ANY OTHER WARRANTIES, EXPRESS OR IMPLIED, INCLUDING BUT NOT LIMITED TO WARRANTY OF MERCHANTABILITY OR WARRANTY OF FITNESS FOR A PARTICULAR PURPOSE.

Graco's sole obligation and buyer's sole remedy for any breach of warranty shall be as set forth above. The buyer agrees that no other remedy (including, but not limited to, incidental or consequential damages for lost profits, lost sales, injury to person or property, or any other incidental or consequential loss) shall be available. Any action for breach of warranty must be brought within two (2) years of the date of sale.

GRACO MAKES NO WARRANTY, AND DISCLAIMS ALL IMPLIED WARRANTIES OF MERCHANTABILITY AND FITNESS FOR A PARTICULAR PURPOSE, IN CONNECTION WITH ACCESSORIES, EQUIPMENT, MATERIALS OR COMPONENTS SOLD BUT NOT MANUFACTURED BY GRACO. These items sold, but not manufactured by Graco (such as electric motors, switches, hose, etc.), are subject to the warranty, if any, of their manufacturer. Graco will provide purchaser with reasonable assistance in making any claim for breach of these warranties.

In no event will Graco be liable for indirect, incidental, special or consequential damages resulting from Graco supplying equipment hereunder, or the furnishing, performance, or use of any products or other goods sold hereto, whether due to a breach of contract, breach of warranty, the negligence of Graco, or otherwise.

FOR GRACO CANADA CUSTOMERS

The Parties acknowledge that they have required that the present document, as well as all documents, notices and legal proceedings entered into, given or instituted pursuant hereto or relating directly or indirectly hereto, be drawn up in English. Les parties reconnaissent avoir convenu que la rédaction du présente document sera en Anglais, ainsi que tous documents, avis et procédures judiciaires exécutés, donnés ou intentés, à la suite de ou en rapport, directement ou indirectement, avec les procédures concernées.

Graco Information

For the latest information about Graco products, visit www.graco.com.
For patent information, see www.graco.com/patents.

To place an order, contact your Graco Distributor or call to identify the nearest distributor.

Phone: 612-623-6921 **or Toll Free:** 1-800-328-0211 **Fax:** 612-378-3505

All written and visual data contained in this document reflects the latest product information available at the time of publication.

Graco reserves the right to make changes at any time without notice.

Original Instructions. This manual contains English. MM 3A6948

Graco Headquarters: Minneapolis

International Offices: Belgium, China, Japan, Korea

GRACO INC. AND SUBSIDIARIES • P.O. BOX 1441 • MINNEAPOLIS MN 55440-1441 • USA
Copyright 2019, Graco, Inc. All Graco manufacturing locations are registered to ISO 9001.

www.graco.com
Revision A, 11/2019