

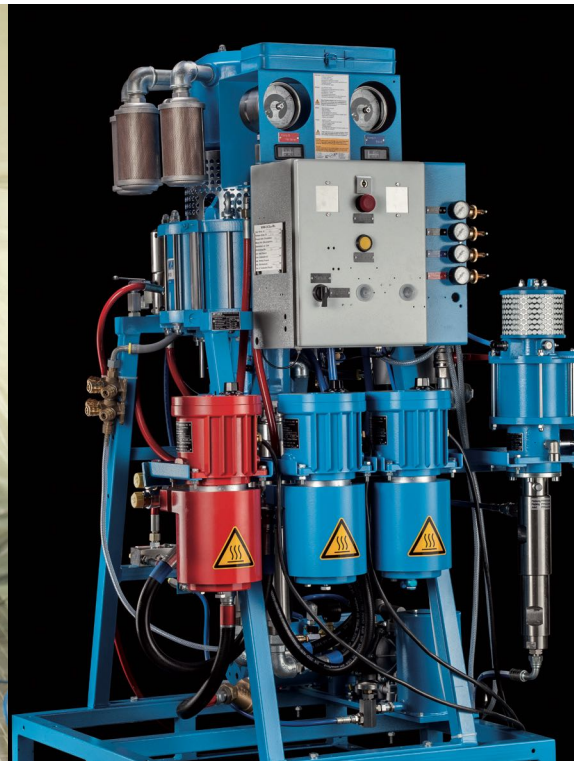

because it works



DUOMIX

WWW.WIWA.COM



because it works

PRODUCT RANGE

WIWA's extensive product range includes 1K, 2K and 3K application equipment for painting, coating and bonding in the machinery and vehicle manufacturing industries and for large surface, high viscosity and high build coatings used in the marine and offshore industries and steel and masonry construction for corrosion-proofing, surface sealing and passive fire protection.



ATEX 94/9/EG

Head Office and Production Germany

WIWA Wilhelm Wagner GmbH & Co. KG
Gewerbstrasse 1-3
35633 Lahnau
Phone: +49 6441 609-0

www.wiwa.de

WIWA Subsidiary USA

WIWA LLC – USA, Canada, Latin America
107 N. Main St.
P.O. Box 398, Alger, OH 45812
Tel.: +1-419-757-0141
Fax: +1-419-549-5173
Toll-Free: +1-855-757-0141

www.wiwausa.com



WIWA FLEXIMIX 2 electronic plural component spray equipment



WIWA DUOMIX, pneumatic plural component spray equipment



WIWA DUOMIX PU HX, hydraulic plural component spray equipment



WIWA DUOMIX 333 PFP ATEX, for intumescent fire protection material



WIWA HERKULES 333 GX, single feed (airless) spray equipment



WIWA VULKAN, pneumatic extrusion equipment

www.wiwa.com

PERFECT SOLUTIONS FOR EVERY APPLICATION AREA...
...THOUGH A MODULAR SYSTEM CONCEPT



The globally proven WIWA 2K range for large-surface coatings

The DUOMIX demonstrates its particular strengths when used for the processing of highly viscous, solvent-free 2K or 3K materials with extremely short pot lives (under 30 seconds).

Huge advantages in all application areas

- Rapidly interchangeable mixing ratio (process assurance)
- Mixing ratios of 1:1 to 10:1
- Feed volumes per double stroke of up to 700 cc
- Pressure ratios of up to 85:1
- High efficiency
- Large performance range
- Individual solutions through modular system concept
- Environmentally friendly due to solvent savings
- EX-protection due to compressed air operation

Application areas

Waste water treatment

Marine and offshore industry

Rail

Container construction

Pipe and pipeline coating

Pipeline refurbishment

Steel and hall construction

Wagon factories

Container construction

Building and corrosion protection

Wind power industry

Tank construction

Secondary overflow protection

Paint supply systems

Materials

Low and high-viscous materials

2-component materials

3-component materials

Solvent-based materials

High-solid materials

Solvent-free materials

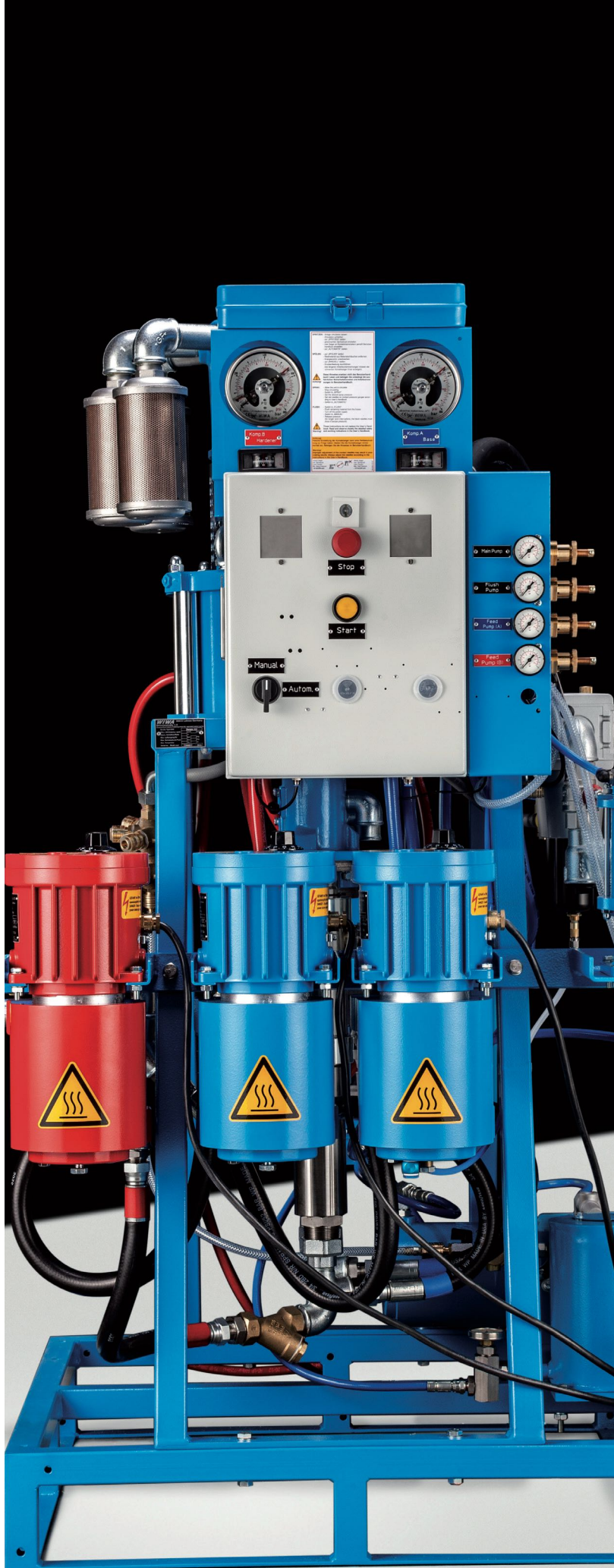

EFFICIENT AND ENVIRONMENTALLY FRIENDLY... ...WIWA DUOMIX RANGE

Advantages that add up

- Modular system concept
- Powerful performance with high proportioning accuracy
- Low maintenance due to consistently high WIWA quality standard
- No faulty coatings due to automatic shut-off upon exceeding pressure limits
- Long service life due to non-tipping direct drive of the material pumps
- Simple documentation of the work through optional data logging
- Simple and safe operation

Environmentally friendly

This is how WIWA protects the environment

- Reduced material and flushing media consumption due to short spray hoses between the mixing block and gun
- The system is designed for the use of large containers; this avoids special waste such as paint buckets with material residues
- Low odour nuisance during application and the drying phase

Efficient

Reduced drying, storage and downtime costs

- Due to its mixing ratio, the DUOMIX can process materials with the shortest pot lives and curing times in almost all application areas. This reduces throughput, drying and downtime costs
- Only the required material quantity is mixed - meaning no material loss

Working time savings

- Rapid start-up
- Rapid shut-down of the system after work, because it is only necessary to flush the spray hose between the mixing block and gun
- Application of high layer thicknesses in a single working process
- Interruption-free work through the use of the automatic WIWA refill system



MIXING RATIO 1:1 TO 10:1... ...SIMPLE - FLEXIBLE - ASSURED

The guarantee for precise proportioning and variable mixing

- **Flexible:** WIWA DUOMIX – the world's only 2K system that offers you the flexibility of a variably adjustable 2K system and the assurance of a fixed mixing ratio, and which can be used as a 3K system.
- **Simple:** With just a few actions, you set the DUOMIX to the desired mixing ratio. Time-consuming ratio checking and adjustment are superfluous, and accidental adjustment is impossible.
- **Assured:** The fixed mixing ratio provides you with process assurance. Accidental adjustment and resultant faulty coatings are impossible.

The simple principle: Individually flexible

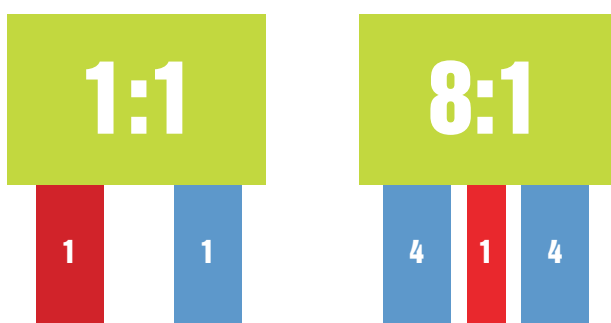

With just a few actions it is possible to modify the system for almost all mixing ratios within a range of 1:1 to 10:1 (also in the decimal range, such as 5.6:1), by exchanging the hardener pump.

The basic modules

1 Air motor

The air motor with de-icing system and maintenance unit in robust metal design. It is equipped with a piston rod and two guide axes, which are guided in the upper and lower section. This guarantees the non-tipping direct drive of all material pumps, whilst the wear of packing and piston rods is also minimised.

Material pump combination

2 If new fields of activity should require alternative performance parameters, this is only possible by replacing the material pumps.

3 A closed flushing media chamber separates the air motor and material pumps. The flushing media prevents paint encrustation on the piston rods and protects the packing due to its lubricating effect.

4 All material pumps are equipped with fixed packing, which is automatically adjusted with packing tensioners. Manual adjustment of the packing is not necessary.

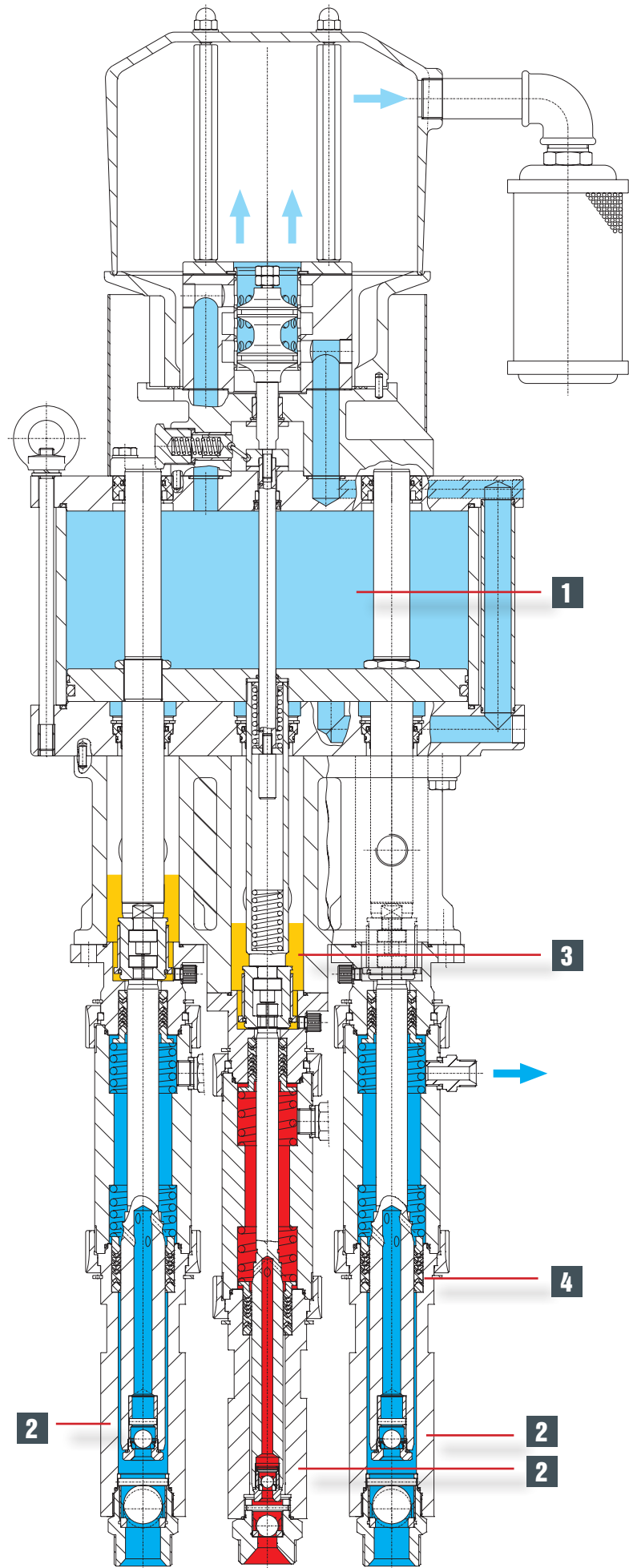

MODULES OF PERFECTION FOR YOUR... ...INDIVIDUAL SYSTEM

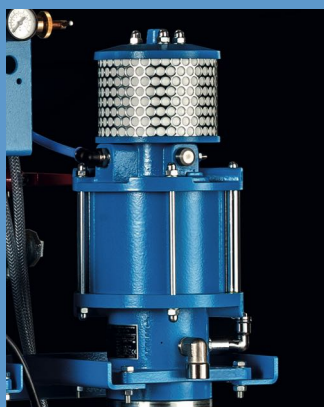
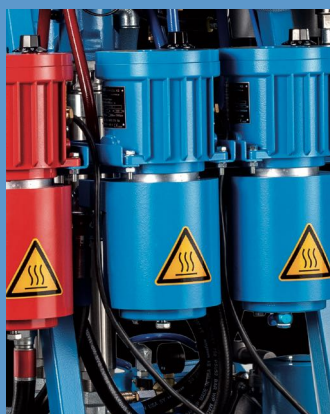

Heating systems

A range of different heating options are available for low outside temperatures, highly viscose materials and coatings with high temperature processing:

- EX-protected material heaters (3.5 kW) approved up to 450 bar
- Hose heating (electrically / hot-water heated)
- Barrel floor heaters or heating tape
- Water-heated inflow hoppers

Feed pumps and feed systems

When processing highly viscose materials you obtain DUOMIX parts, which ensure an optimally tailored supply:

- Inflow hopper
- Membrane pump
- Piston pump
- Automatic top-up system for 200 litre barrels (they guarantee interruption-free operation)

Flushing pumps

Flushing pumps for cleaning all system parts that come into contact with the mixed material.



Material pumps

The fixed mixing ratio is determined based on the sizes of the material pumps and hardener pump.

However, it can be adjusted by simply changing the pumps.

The material pumps are equipped with fixed packing that is automatically adjusted with packing tensioners.

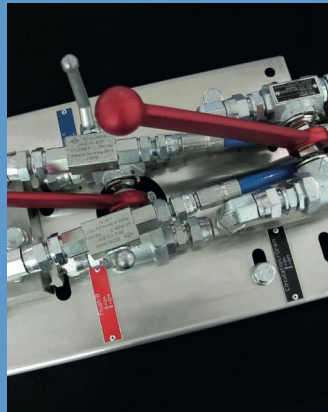

Mixing block

The pneumatic mixing block with flushing device and static mixer is available with manually actuated valves or remote control.

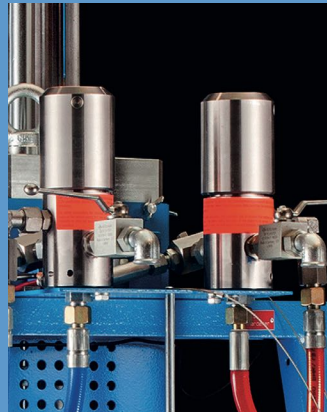

High pressure filter

A rupture disc device, integrated as standard, protects the system against exceeding the maximum permissible working pressure and any damage.

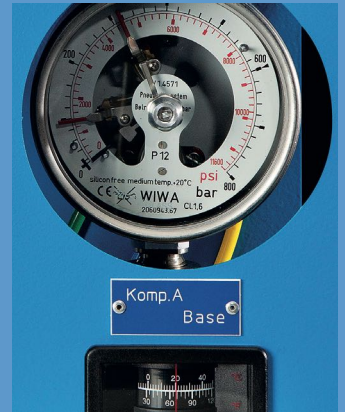

Pressure and proportioning monitoring

Using this equipment it is possible to monitor the mixing ratio. In order to avoid defective mixing, the pressures of both components are monitored by contact manometers. If the set tolerance ranges are undercut or exceeded, the system switches off automatically.

MODULES OF PERFECTION FOR YOUR... ...INDIVIDUAL SYSTEM

The optimum design and equipment

From delivery container to airless spray gun - the diversity of the modules, in combination with the range of performance variants, is almost limitless.

Modular construction

The design of the DUOMIX system is tailored to the application area and the spray material.

Depending on the application area, the WIWA DUOMIX system can be designed as a fixed, complete system, or as spatially separated modules.

The DUOMIX principle: Individually modular

Complete system

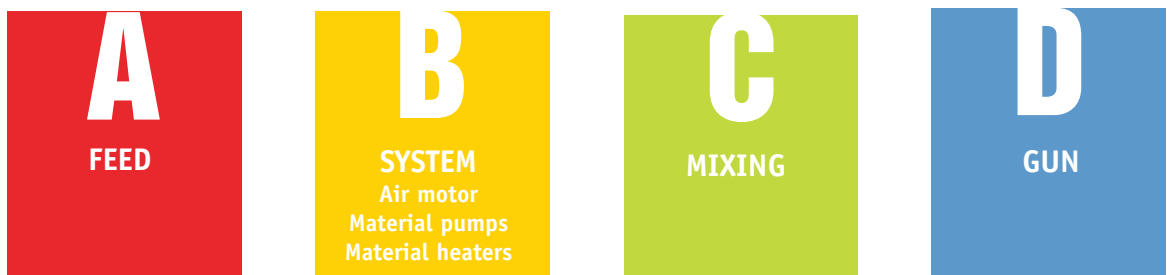

Spatially separated modules



Possible variations



Possible variations



Possible variations



WIWA DUOMIX...

...suitable for short pot lives

In use globally for the processing of highly viscous, solvent-free 2K or 3K materials with particular strengths with extremely short pot lives (under 30 seconds).

...for high to low viscose materials

Large performance range for almost all low to high viscose 2K coatings.

...with interchangeable mixing ratio

With just a few actions it is possible to change the material pumps and therefore also the material ratio.

...with higher wear resistance

Non-tipping direct drive of all material pumps.

...reliable in all temperature ranges

Decentralised use of the heating systems for the perfect coating, even with low ambient temperatures.

...for 3 components

Due to the special design, it is also possible to use the WIWA DUOMIX system as a 3K processing system.

...with modular design

Based on almost limitless modular solution diversity, every system is designed according to the special requirements of the customer.

...as a mobile system

Suitable for transport in all site areas:

- with crane eyes
- with mobile frame
- on forklift pallet



MODULAR DIVERSITY...
...WITH TOP CLASS TECHNOLOGY

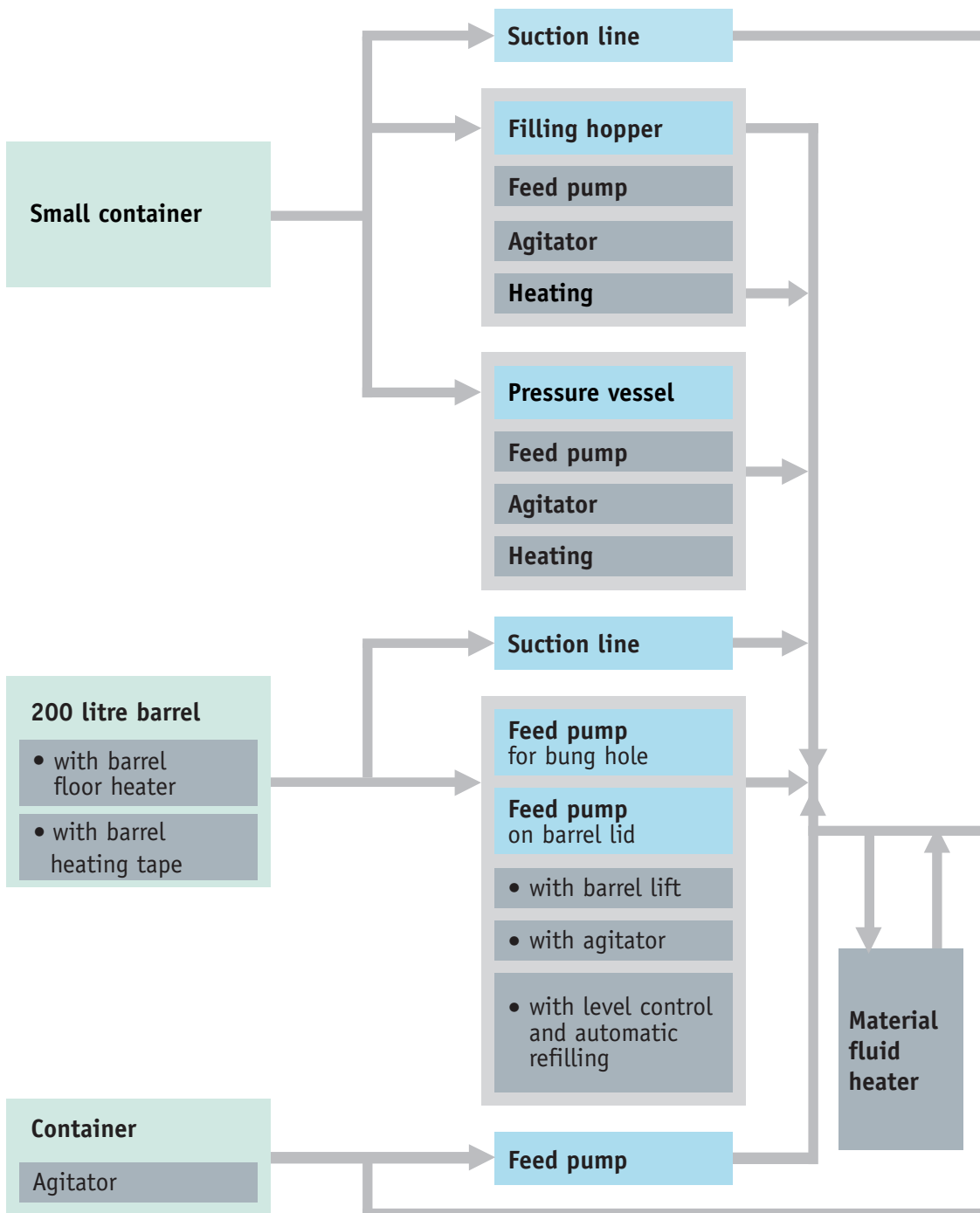



- Delivery container
- System components
- Accessories

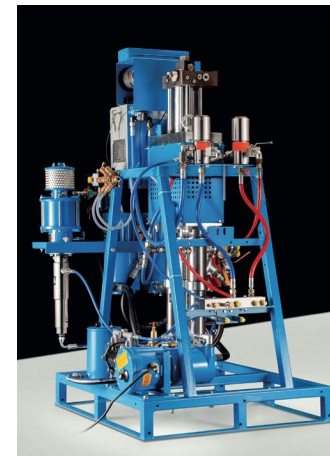
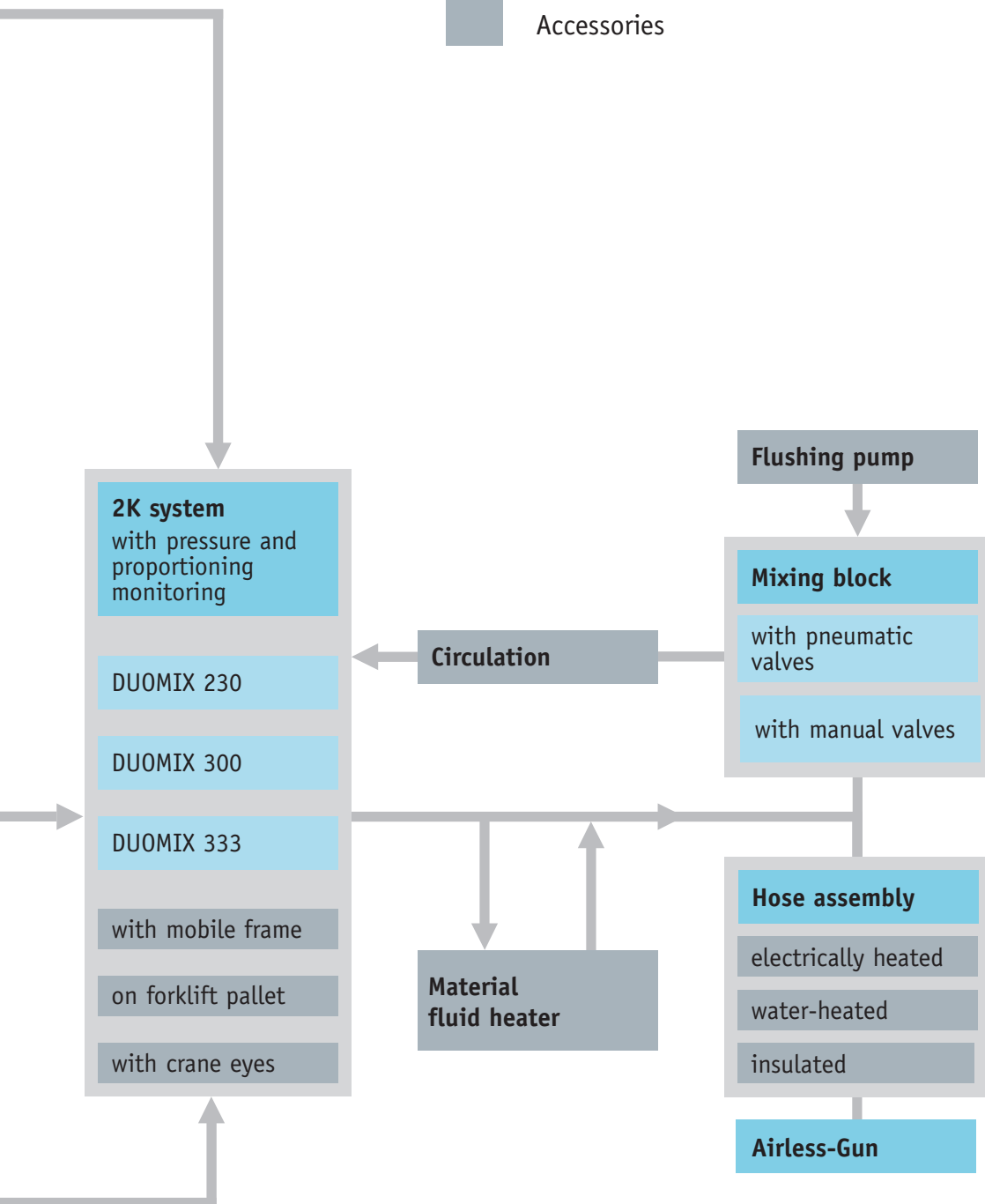

THE EQUIPMENT... ...FROM OPTIMUM TO INDIVIDUAL

DUOMIX POWERPACK XL

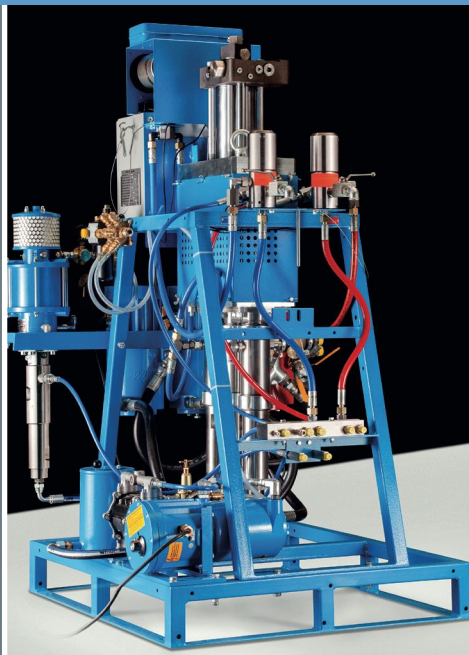

DUOMIX 230



DUOMIX 300/333

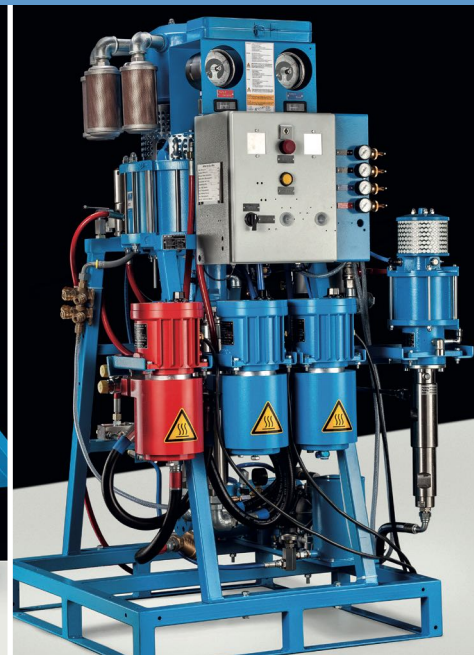

WIWA POWER PACK XL and XXL: High performance systems with hydraulic drive

WIWA POWER PACK XL and XXL with hydraulic drive concept.

The POWER-PACK systems are specially designed for continuous operation with high output rates and stand out due to a long service life and low maintenance costs.

The pumps can be integrated into existing hydraulic systems with ease. Hydraulic systems from the POWER-PACK range offer an optimum solution for operations or application areas without a compressed air supply.

Individual solutions using serial modules

WIWA designs the „tailored“ DUOMIX high performance spraying system for every application area. This largely consists of modular parts.

The result is a system that is optimally equipped for the respective application area, with an economical price/performance ratio and proven quality, designed for continuous use. The supply of wearing and spare parts is also guaranteed through the use of serial parts.

DUOMIX technical data	230	300/333	POWERPACK XL	POWERPACK XXL
Volumetric mixing ratio	1:1 bis 10:1	1:1 bis 10:1	1:1 bis 10:1	1:1 bis 8:1
Pressure ratio	up to 75:1	up to 85:1	up to 4:1	up to 4:1
Maximum permissible spray pressure	450 bar	450 bar	450 bar	450 bar
Max. output per double stroke	266 cm ³	715 cm ³	292 cm ³	1.100 cm ³
Max. output with 60 double strokes	10 l	28 l	10 l	44 l
Max. inlet pressure	8 bar	8 bar	200 bar	200 bar

Basic equipment

- WIWA proportioning pump
- Robust frame for accommodating all parts
- Maintenance unit complete with all connections
- Safety equipment (rupture discs) in the high pressure range for both components

Auxiliary equipment

Feed pumps or inflow hoppers

- High pressure filter for base material and hardener with material relief or draining (circulation)
- Complete pressure and proportioning monitoring for both components with automatic switch-off upon exceeding the set tolerances
- Flushing pump for cleaning the parts that come into contact with the mixed material
- EX-protected WIWA material fluid heater with a rating of 3.5 kW (can be controlled from 20°– 85°C)
- Pneumatic stroke counter for quantity control.
- Hose assembly, insulated or heated (electric or water heating)
- Pneumatic mixing block with static mixer and flushing device